

МИНИСТЕРСТВО ВНУТРЕННИХ ДЕЛ РОССИЙСКОЙ ФЕДЕРАЦИИ

ВОЛГОГРАДСКАЯ АКАДЕМИЯ

СУДЕБНАЯ ЭКСПЕРТИЗА

FORENSIC EXAMINATION

№ 1 (53)

ВОЛГОГРАД — 2018

НАУЧНО–ПРАКТИЧЕСКИЙ ЖУРНАЛ

СУДЕБНАЯ ЭКСПЕРТИЗА 1 (53) 2018

ISSN 1813-4327

1 (53) 2018 : - . . .
: , 2018. . 136 .

2004 . 4 500

www.elibrary.ru

3 2011 .
77-47195

: www.va-mvd.ru/sudek/

« » . 46462

« »

© , 2018

**СОСТАВ РЕДАКЦИОННОГО СОВЕТА
ЖУРНАЛА «СУДЕБНАЯ ЭКСПЕРТИЗА»**

1. [faint text]
2. [faint text]
3. [faint text]
4. [faint text]
5. ([faint text]).
6. [faint text]
7. [faint text]
8. [faint text]
9. [faint text] 2
10. [faint text]
11. [faint text]
12. [faint text]

¹ . « [faint text] ».
² . « [faint text] ».

13. , , -

14. , ,

15. , , -

16. , ,

17. , , -

18. , , -

19. , , -

20. , ,

21. , ,

22. , , -

23. , , -

24. , , -

25. (,), , -

26. , ,

27. II, , -

28. , ,

.....	õ õ õ õ õ õ õ õ õ õ õ õ õ õ õ õ õ .	7
.....	:	
.....	õ õ õ õ õ õ õ õ õ õ õ õ õ õ õ õ õ	15
.....	õ õ	25
.....	õ õ õ õ õ õ ..õ	33
.....	õ õ õ õ õ õ õ õ õ õ õ õ õ õ õ õ õõ	41
.....	õ õ õ õ õ õ õ õ õ õ õ õ õ õ õ õ õ ..õ õ .õ õ õ õ õ õ õ ..õ	54
.....	õ õ õ õ õ õ õ õ ..õ õ	61
.....	õ õ õ õ õ õ õ õ õ õ õ õ õ õ õ õ õ õ ..õ ..õ	71
.....	õ õ õ õ ..õ õ õ õ	84
.....	õ õ õ õ õ õ õ õ õ õ õ õ õ õ õ õ õ ..õ	93
.....	õ õ õ õ õ õ õ õ ..õ õ õ	102
.....	:	
.....	? õ ..õ	113
.....	5,45- -74 , -105 -74 õ õ õ õ õ õ õõ	121
.....	õ ..õ õ õ õ õ õ ..õ õ õ õ õõ	129

CONTENTS

ORGANIZATIONAL AND LEGAL ASPECTS OF FORENSIC EXPERT ACTIVITIES AND THE USE OF SPECIAL KNOWLEDGE IN LEGAL PROCEEDINGS

<i>Vehov V. B., Kovalev S. A.</i> Using special knowledge to obtain evidence of computer information from the organizers of its distribution on the internet ..	7
<i>Matveichev Yu. A.</i> Interrogation and getting of an explanation from the expert at the pre-trial stages of the criminal process in the Republic of Belarus: deficiencies in legislation and ways to eliminate them ..	15
<i>Akifeva G. V.</i> Model of the special economical knowledge and tasks, which can be solved with their held during crime investigation related to receiving of the loan ..	25

PROBLEMS OF THEORY AND PRACTICE OF FORENSIC EXAMINATIONS AND RESEARCH

<i>Bobovkin M. V., Ruchkin V. A.</i> The main trends of development of forensic handwriting examination in the Russian Federation ..	33
<i>Rubis A. S., Lappo Y. A., Kozlov V. L., Vasilchuk A. S.</i> Using correlative processing of digital images in forensic ballistics ..	41
<i>Butyrin A. Yu., Danilkin I. A.</i> Production of legal construction technical expertises within the conditions of lack of basic data ..	54
<i>Bozhchenko A. P., Gomon A. A.</i> Combinatory analysis as a method of research in forensic medical dermatoglyphic and dactiloscopia ..	61
<i>Koshmanov P. M., Koshmanov M. P., Komnatin V. G.</i> A flourish in the completion phase of structuring a signature, its significance and functions ..	71
<i>Vasilyev V. A., Evstropov D. A., Krainsky A. V.</i> Comprehensive approach while examination of sudoral and fatty substances ..	84
<i>Ilyin N. N.</i> On the role of the expert experiment in the production of judicial-portrait examination ..	93
<i>Kitaev E. V.</i> Concerning some constructional peculiarities and ways of unlocking mongolian handcrafted locks ..	102

SCIENTIFIC DISCUSSION AND EXPERIENCE EXCHANGE

<i>Danilovich V. B.</i> Research techniques for crossing strokes: Myth or reality? ..	113
<i>Chulkov I. A., Kopanov A. S.</i> Peculiarities of traces of a close-range gunshot when firing the 5,45 mm AK-74M, AK-105, and AKS-74U assault rifles ..	121

CONTACT INFORMATION ..	129
-------------------------------	-----



V. B. Vehov,

Professor department of jurisprudence, intellectual property and forensic examination of Moscow state technical University n. a. N. Uh. Bauman, Doctor of Juridical Sciences, Professor;

S. A. Kovalev,

Associate professor department of criminalistic equipment of educational-scientific complex forensic activities, Volgograd Academy of the Ministry of the Interior of the Russian Federation, Candidate of Juridical Sciences, Associate Professor

USING SPECIAL KNOWLEDGE TO OBTAIN EVIDENCE OF COMPUTER INFORMATION FROM THE ORGANIZERS OF ITS DISTRIBUTION ON THE INTERNET

The article do represent theoretical and practical problems of using of a complex of special knowledge to get a computer information as an evidence from internet distributors of such information. The authors do suggest the ways of solving those problems. The article do consider the changings of the legislation in the sphere of Telecom, information technologies and information security, the changings of criminal procedure of Russian Federation.

To make classification of computer information that have forensic meaning the authors suggest to use such legislative determined forms of its representation: network address, domain name, file, digital signature, digital message, digital document, software, database, information system, internet site, web-page, digital currency.

The authors describes the list of digital data that distributors of information and Telecom providers should to collect, store and provide to law enforcement officials based on home country legislation.

The authors did a research of latest legislative rules that allows increasing the quantity of procedure instruments of law enforcement to work with internet based



computer information as an evidence. Based on that research the article describes special knowledge should be used for correct search and seizure of digital messages execution. Basic rule for it is 185 article of criminal procedure code of Russian Federation.

Moreover, the authors do explore the ways to increase effectiveness of execution of criminal procedure named Obtaining information about connections between subscribers and (or) subscriber devices (regulated by article 186.1 of criminal procedure code of Russian Federation). This criminal procedure is consist of obtaining data about date, time, duration of subscribers` or subscriber devices` connections, their ID and other information that allows determine the identity of subscribers likewise a data about identification number and location of base stations (describes by article paragraph 24,1 article 5 of criminal procedure code of Russian Federation).

Key words: electronic evidence, computer evidence information, special knowledge, legal obtaining computer information.

1 . 74
 (.)
 , , ,
 , .
 .
 (.)
 [1, . 158]. . 1 . 272
 (.)
 : , , ,
 , , , ,
 , , , [2, . 14, 15].
 ,
 .
 - ,
 ,
 [3].
 ,



6 2016 . 375- «

» . 185 «

.7

: «

» (.9 .2

).

7 2003 . 126-

« » [4, .2 .13],

.64

1)

()

[5, .14]:

()

()



2) , , , - .

27 2006 . 149- « . 10.1
» [4, . 15], -
() , -
() , , -
() , . -
1. : -
, , , () -
, , , , [6, . 3]: -
) - , « »; -
) : -
. , ; -
, , (. « ») -
; -
. , ; -
. , ; -
) , : -
, ; -
. ; -
. ; -
) ; -
) ; -
: -
. ; -
. ; -



(, ,);

) ;

;

) ;

, () -

);

) () -

(, () -

);

) () ;

;

);

() ;

(« »), , -

);

2. , , -

3. , () -

1) ;

2) ;

3) ;

); () -

4) () -



()	;	()	-
5)			-
			-
			-
		()	-
			-
			-
			-
		()	-
			-
	186.1	«	-
		()	».
	()	(-
)			-
	(. 24.1 . 5)		-
			-
			-
	[7].	()	-
			-
			-
			-
			-
		()	-
			-
			-



1. Vehov V. B. Ponjatie, vidy i osobennosti fiksacii jelektronnyh dokazatel'stv // Rassledovanie prestuplenij: problemy i puti ih reshenija. 2016. 1 (11). S. 155- 158.
2. Vehov V. B., Smagorinskij B. P., Kovalev S. A. Jelektronnye sledy v sisteme kriminalistiki // Sudebnaja jekspertiza. 2016. 2 (46). S. 10- 19.
3. Vehov V. B. Rabota s jelektronnymi dokazatel'stvami v uslovijah izmenivshegosja ugolovno-processual'nogo zakonodatel'stva // Rossijskij sledovatel'. 2013. 10. S. 22- 24.
4. « »
5. : 6 2016 . 374- . « ».
6. 538. « ».
7. () // . 2012. 1 (20). S. 79- 82.

References

1. Vehov V. B. Ponjatie, vidy i osobennosti fiksacii jelektronnyh dokazatel'stv // Rassledovanie prestuplenij: problemy i puti ih reshenija. 2016. 1 (11). S. 155- 158.
2. Vehov V. B., Smagorinskij B. P., Kovalev S. A. Jelektronnye sledy v sisteme kriminalistiki // Sudebnaja jekspertiza. 2016. 2 (46). S. 10- 19.
3. Vehov V. B. Rabota s jelektronnymi dokazatel'stvami v uslovijah izmenivshegosja ugolovno-processual'nogo zakonodatel'stva // Rossijskij sledovatel'. 2013. 10. S. 22- 24.



4. O vnesenii izmenenij v Federal'nyj zakon «O protivodejstvii terrorizmu» i ot-del'nye zakonodatel'nye akty Rossijskoj Federacii v chasti ustanovlenija dopol-nitel'nyh mer protivodejstvija terrorizmu i obespechenija obshhestvennoj bezopas-nosti: feder. zakon ot 6 ijulja 2016 g. 374-FZ. Dostup iz sprav.-pravovoj sistemy «Konsul'tantPljus».

5. Pravila vzaimodejstvija operatorov svjazi s upolnomochennymi gosudarstven-nymi organami, osushhestvljajushhimi operativno-razysknuju dejatel'nost': utv. postanovleniem Pravitel'stva Rossijskoj Federacii ot 27 ijulja 2005 g. 538. Dostup iz sprav.-pravovoj sistemy «Konsul'tantPljus».

6. Pravila hranenija organizatorami rasprostranenija informacii v informacionno-telekommunikacionnoj seti Internet informacii o faktah priema, peredachi, dostavki i (ili) obrabotki golosovoj informacii, pis'mennogo teksta, izobrazhenij, zvukov ili inyh jelektronnyh soobshhenij pol'zovatelej informacionno-telekommunikacionnoj seti Internet i informacii ob jetih pol'zovateljah, predstavlenija ee upolnomochennym go-sudarstvennym organam, osushhestvljajushhim operativno-razysknuju dejatel'nost' ili obespechenie bezopasnosti Rossijskoj Federacii: utv. postanovleniem Pravitel'stva Rossijskoj Federacii ot 31 ijulja 2014 g. 759. Dostup iz sprav.-pravovoj sistemy «Konsul'tantPljus».

7. Vehov V. B. Taktika poluchenija informacii o soedinenijah mezhd u abonentami i (ili) abonentskimi ustrojstvami // Vestnik Volgogradskoj akademii MVD Rossii. 2012. 1 (20). S. 79- 82.

© . . . , . . . , 2018

94-1 « »; 2)



; 3)

; 4)

; 5)

(),

Yu. A. Matveichev,

Deputy Head of the Mogilev Institute of the Ministry of Internal Affairs
of the Republic of Belarus, Candidate of Juridical Sciences, Associate Professor

**INTERROGATION AND GETTING OF AN EXPLANATION
FROM THE EXPERT AT THE PRE-TRIAL STAGES
OF THE CRIMINAL PROCESS IN THE REPUBLIC OF BELARUS:
DEFICIENCIES IN LEGISLATION AND WAYS TO ELIMINATE THEM**

The article reveals deficiencies in the legal regulation of interrogation and getting explanations from the expert at the pre-trial stages of the criminal process of the Republic of Belarus on the basis of an analysis of the criminal procedural legislation and law enforcement practice.

In order to eliminate them, it is proposed to: 1) include the expert's testimony in the list of sources of evidence and supplement the Criminal Procedure Code of the Republic of Belarus with Article 94-1, «Testimony of the expert»; 2) to provide the person conducting the inquiry with the right to interrogate and get an explanation from the expert; 3) to allow the expert to be interrogated and getting explanations from him for clarifying the report on the impossibility of giving an opinion; 4) to provide for the possibility of interrogation and getting explanations from an expert using videoconferencing systems; 5) to complement the Criminal Procedure Code of the Republic of Belarus with the rules that determine the procedure for calling an expert for interrogation (getting an explanation), as well as with the rules that detailing the procedure for carrying out these procedural actions and the rules for drawing up protocols based on their results.

Key words: forensic examination, expert, sources of evidence, expert testimony, expert report, report on impossibility of giving an opinion, interrogation of an expert,



interrogation with the use of videoconferencing systems, getting explanations from an expert.

(. 1 . 105 -
(. 2 . 95) .
59 26
() , 40
[. 1 . 2] (-
[. 1, . 3;
. 2, . 1)]* .
)** .
(. 1 . 237
) , .
(. 1 . 335) .
« »
- [6, . 636].
. 2 . 14
29 2001 . 1 «
»
[7].



« »
- [6, . 535].
(. 3 . 14) [7].
(. . . . 1 . 239)
. 237, . 335 . 1 . 237
1. (. 4 . 34)
2. (. 236)
(. 1 . 95)



.....

.....

..... ;

..... ;

..... ;

..... (. 3 . 236) .

..... ([2, . 68]) *** . . 1 . 237

.....)

..... ;

1) (

« » . . 1 . 237) .

..... « »

..... (. 91) ,

(. 92) , (. 94) ; (. 93) ,

2) (

. 1 . 237

..... 193 « »

194 « ») .

..... (.....) ,

..... ? : , - ,

..... , . 1 . 88

..... «

..... » , . 2 . 88

..... 94-1 :

« 94-1 .

1. ,

..... ;



237, 335 .».

(),

2016 .

- (. 224-1).

224-1

1) ;

2) (

3)); (- ,

4));

?

1) . 2 . 88
94-1 « »;



2)	. 237	-
:		-
,		-
;		-
;		-
-	. 237	-
	:	-
«	237.	-
1.	,	-
		-
		-
	193 194	-
2.		-
		-
2.	11 . 224-1	-
3.		-
	.»;	-
3)	:	-
		-
	;	-
	()	-
		-
<hr/>		
*		-
		-
	2011. 2012 . [1].	-
		-
**		-
	[2; 3; 4; 5].	-
***		-
	[. 2, . 4] [. 1, . 4]	-
	,	-



1

59

2017 . . 2018 .

33

. 1. 4.

1

?

	26
	7

2

?

	15
	18

3

?

-	25
	4
	2
	2
	1
	1
-	1
	1
	1
	1
-	1
	1
	1



4

?

	33
-	1

2

2018 . 26

7

. 1. 2.

1

?

-	6
	1

2

?

	6
	1

1. [.] // . 2013. 1 (33).
. 22. 28.



2. // . 2016. 3 (39). S. 67- 71.
3. // . 2016. 1 (25). S. 39- 44.
4. // . 2016. 2 (38). S. 54- 59.
5. // . 2017. 3 (43). S. 40- 44.
6. : 4 .4- ,, . : . : . 1999. .3: . .
7. : 29 2001 . 1: . 31.03.2016. « : » . 3000 / « », . . 2017.

References

1. Nekotorye aspekty doprosa jeksperta v sude / Ju. V. Ponomarenko [i dr.] // Voprosy kriminologii, kriminalistiki i sudebnoj jekspertizy. 2013. 1 (33). S. 22- 28.
2. Rubis A. Takticheskie osobennosti doprosa jeksperta po soobshhenijam o nevozmozhnosti dachi zakljuchenija // Zakonnost' i pravoporjadok. 2016. 3 (39). S. 67- 71.
3. Rubis A. Ocenka dostovernosti zakljuchenija jeksperta v ugovolnom processe i problemy jekspertnogo obespechenija pravosudija v Respublike Belarus' // Zakonnost' i pravoporjadok. 2016. 1 (25). S. 39- 44.
4. Rubis A. Osnovy taktiki doprosa jeksperta // Zakonnost' i pravoporjadok. 2016. 2 (38). S. 54- 59.
5. Rubis A. Takticheskie osobennosti doprosa jeksperta pri formulirovanii im vyvodov o nevozmozhnosti reshenija voprosov po sushhestvu // Zakonnost' i pravoporjadok. 2017. 3 (43). S. 40- 44.
6. Slovar' russkogo jazyka: v 4 t. 4-e izd., stereotip. M.: Rus. jaz.: Poligrafresursy, 1999. T. 3: P. R.
7. O sudebnoj jekspertize po ugovolnym delam: postanovlenie Plenuma Verhovnogo Suda Respubliki Belarus' ot 29 marta 2001 g. 1: v red. ot 31.03.2016. Dostup iz sprav.-pravovoj sistemy «Konsul'tantPljus: Belarus'». Tehnologija 3000 / OOO «Jur-Spektr», Nac. centr pravovoj inform. Resp. Belarus'. Minsk, 2017.

© . . , 2018



Federation, Article 159 of the Criminal Code of the Russian Federation, Article 201 of the Criminal Code of the Russian Federation. This definition of the model was formulated by the author taking into account the peculiarities of credit organizations, the limited access to their internal regulatory documents, the differentiation in the classification of crimes on illegal loan obtaining, as well as the specifics of the implementation of the investigation tasks by means of using special economic knowledge. In the same article the author considers the list and content of organizational tactical tasks solved with their help. These include such tasks as setting the kind of illegally obtained credit, identify the characteristics of the current lending process in the credit institution, establishment of sets of internal documents of the credit organization on the regulation of the procedure for lending to a specific group of borrowers, clarifying the order and characteristics of granting a loan to a specific category of borrowers, identifying a differentiated list of documents, potentially containing traces of the crime, helping the investigator to conduct the seizure of documents, in their examination, preliminary study, the establishment of the information to be clarified during the interrogation of representatives of the credit institution, determining the amount of material damage and others.

Key words: illegal receiving of a loan, special economical knowledge, expert-economist, borrower, credit, loan, forensic evidence, specialist advice, material damage.

(. 1, 2 . 176, . 159.1, . 201
(. .)),
() -

[1].

15 1994 .,

;
2011 . 402- « ; 6
»,

(),



« » 176 « » 159.1
2 250
» 1 500

14.11
(.....) « » [2].

1) (.....)
..... ;
2) (.....)
..... ;
3) (.....)
..... ;
4) (.....)
..... ;
..... (.....)



	()	
	()	
1.	()	
2.	()	
3.		
4.		
5.		
	91 %	



()	,	-
.), 9 %	()	,	-
,	,	,	-
6.	()	()	-
-	,	,	-
,	()	,	-
7.	,	,	-
()	,	,	-
5	,	,	-
,	,	,	-
,	,	,	-
8.	,	(-
,	,	,	-
159.1, . 201	,	. 1, 2 . 176,	-
9.	,	,	-
,	,	,	-
,	,	,	-
,	,	,	-
;	,	,	-
;	,	,	-
,	;	(-
)	,	,	-
,	,	,	-
10.	,	,	-



11. ()

12. [3; 4].

13. (. 176, 159.1, 201 , 14.11).

[6].



1, 2	176,	159.1,	201	,	-
-	,	,	,	,	-
,	,	-	,	.	-
1.	13	1996	63-	.	-
	«	».			-
2.	30	2001	195-	.	-
	».				-
3.	:	29	2005	.	-
	«	».	511.		-
4.	()	,		-
,	,	,	,		-
27	2012	237.	.	«	-
».					-
5.	.	.,	.	.	-
	:	.	-	.	..
, 2011.					-
6.	.	.,	.	.	-
	(-	,)	4-
.,	,	,	,	.	.
..	,	2016.			-

References

1. Uголовный кодекс Российской Федерации от 13 июня 1996 г. 63-FZ. Доступ из справ.-правовой системы «КонсультантПлюс».
2. Кодекс Российской Федерации об административных правонарушениях от 30 декабря 2001 г. 195-FZ. Доступ из справ.-правовой системы «КонсультантПлюс».
3. Вопросы организации производства судебных экспертиз в экспертно-криминалистических подразделениях органов внутренних дел Российской Федерации: приказ МВД России от 29 июня 2005 г. 511. Доступ из справ.-правовой системы «КонсультантПлюс».
4. Об утверждении Перечня родов (видов) судебных экспертиз, выполняемых в федеральных бюджетных судебно-экспертных учреждениях Минюста России,



i Perechnja jekspertnyh special'nostej, po kotorym predstavljaetsja pravo samostojatel'nogo proizvodstva sudebnyh jekspertiz v federal'nyh bjudzhetnyh sudebno-jekspertnyh uchrezhdenijah Minjusta Rossii: prikaz Minjusta Rossii ot 27 dekabnja 2012 g. 237. Dostup iz sprav.-pravovoj sistemy «Konsul'tantPljus».

5. Aver'janova T. V., Statkus V. F. Prakticheskoe rukovodstvo po proizvodstvu sudebnyh jekspertiz dlja jekspertov i specialistov: nauch.-prakt. posobie. M.: Jurajt, 2011.

6. D'jakov S. V., Kadnikov N. G. Kommentarij k Ugolovnomu kodeksu Rossijskoj Federacii (nauchno-prakticheskij, postatejnyj). 4-e izd., pererab. i dop. M.: Jurisprudencija, 2016.

© . . ., 2018

* * *



M. V. Bobovkin,

Professor at the Department of Document Examination
of the Training and Scientific Complex of Forensic Examination
of the Moscow University of the Ministry of Interior of Russia n. a. V. Y. Kikot,
Doctor of of Juridical Sciences, Professor;

V. A. Ruchkin,

Professor at the Department of Expert Criminalistic Activity Fundamentals
of the Training and Scientific Complex of Expert Criminalistic Activities
of the Volgograd Academy of the Ministry of Interior of Russia,
Doctor of Juridical Sciences, Professor

**THE MAIN TRENDS OF DEVELOPMENT
OF FORENSIC HANDWRITING EXAMINATION
IN THE RUSSIAN FEDERATION**

The article focuses on the current state and main trends of development of forensic handwriting examination in the Russian Federation. The authors analyze statistical data as well as major provisions of this sphere of forensics and forensic examination.

The authors determine identification problems related to establishing a particular implementer of a manuscript or the fact of implementing a plenty of manuscripts (their fragments) by the same individual or different individuals. The article represents an opinion concerning the system of diagnostic problems related to determining personal characteristics of the manuscript's implementer and internal or external conditions of its implementation.

Significant attention is paid to the trends of development of forensic handwriting examination in the Russian Federation. The authors determine the main and additional priority directions of its development and improvement of effectiveness and organization of its conduct. Among the main directions of forensic handwriting development there are theoretical, experimental, methodological, and organizational tactical ones. The content of each direction is interpreted. The authors come to the conclusion that a comprehensive solution of forensic handwriting problems will facilitate the increase of effectiveness of human rights activity in the Russian Federation.

Key words: handwriting, forensic handwriting examination, identification problems, diagnostic problems, development trends, directions, effectiveness.

(« » . . . -
, « » . . .) ,
 , , ,
 -



1) ;
 2) ;
 3) ;
 4) - . () :
 . - ;
 . ;
 . ;
 .
 . ,
 . « 70- 80- » « - -
 » .
 . -
 . -
 . () ,
 - , -
 . ,
 . « ».
 ,
 1) ;
 2) , -
 ;
 3) ;
 4) , -
 ;
 5) . -
 , -
 () , -



1.	-
2.	-
3.	-
4.	-
5.	-
6.	-
7.	-
8.	-
9.	-
10.	-
11.	-
12.	-
13.	-
14.	-



.....

..... ;

..... -

..... ;

..... ;

..... -

..... -

..... -

..... -

..... -

..... ;

..... ;

.....

..... ;

.....

1. // 2013. 3 (35). S. 26- 32.
2., 1903.

References

1. Bobovkin M. V., Solov'eva N. A. O sistematizacii diagnosticheskikh zadach sudebno-pocherkovedcheskoj jekspertizy // Sudebnaja jekspertiza. 2013. 3 (35). S. 26- 32.
2. Burinskij E. F. Sudebnaja jekspertiza dokumentov. SPb., 1903.

© .., .., 2018



.....	1
.....	2
.....	3
.....	4
.....	5
.....	6
.....	7
.....	8
.....	9
.....	10
.....	11
.....	12
.....	13
.....	14
.....	15
.....	16
.....	17
.....	18
.....	19
.....	20
.....	21
.....	22
.....	23
.....	24
.....	25
.....	26
.....	27
.....	28
.....	29
.....	30
.....	31
.....	32
.....	33
.....	34
.....	35
.....	36
.....	37
.....	38
.....	39
.....	40
.....	41



A. S. Rubis,

Professor at the Department of criminal procedure of the Academy of the Interior Ministry of the Republic of Belarus, Doctor of Juridical Sciences, Professor;

Y. A. Lappo,

Temporarily acting as Head at the Department of criminal procedure and criminalistics of the Mogilev Institute of Ministry of Internal Affairs of the Republic of Belarus, Candidate of Juridical Sciences;

V. L. Kozlov,

Professor at the Department of quantum radiophysics and optoelectronics of the Belarusian state university, Doctor of Engineering Sciences, Professor;

A. S. Vasilchuk,

Senior lecturer at the Department of quantum radiophysics and optoelectronics of the Belarusian State University

**USING CORRELATIVE PROCESSING OF DIGITAL IMAGES
IN FORENSIC BALLISTICS**

Measuring the parameters of forensic-ballistic expertise is an indispensable condition for determining the type and specific specimen of hand-held firearms. At the same time, an analysis of the relevant methods and nomenclature of technical means used in the conduct of forensic ballistic studies shows that at present there are a number of practical questions that need substantive resolution.

The development and introduction into practice of expert departments of modern methods of research of forensic objects contribute to an increase in the scientific level of expert opinions and their validity. Non-destructive methods of research, the necessity of priority application of which is confirmed by practical activities of law enforcement bodies and expert institutions, occupy a special place among these methods.

The theoretical principles and principles of the computer implementation of the algorithm for measuring the traces of hand firearms on bullets and cartridges using methods of correlation analysis of digital images are presented in the article.

It is noted that the development of new programs for processing digital images of objects of expert research will allow expanding the list of methods and instruments of measurement and thereby improve the quality, reliability and representativeness of the studies.



The conclusion is justified that the use of the capabilities of modern computer facilities and specialized software is a promising direction for ensuring the production of forensic ballistics.

Key words: criminalistics, judicial ballistics, firearms, traces of weapons, dimensional and angular characteristics, measuring instrument, correlative processing, digital image, measurement information.

.....
(.....),
.....
(.....),
.....
.....
.....
.....
(.....)
.....
.....
(.....).
.....
(.....) · 4,5^{+0,2},



$442 \cdot 3^{+0.2}$. (.) $-75 \cdot 2^{+0.1}$, -
 . -
 , -
 $6^\circ 23'$, 260 ± 20 , -442
 $-75 \cdot 3^\circ 28'$ 290 ± 20 . -
 () . -
 . -
 , -
 $[1; 2, \dots 63]$. -
 , -
 () -
 , -
 , -
 3×10^{-4} . 8×10^{-3}
 11×10^{-3} .
 15×10^{-3} ; 2×10^{-2}
 $[3, \dots 30, 31]$.
 ()
 (-11) . -
 , -
 $[4, \dots 211, 212]$. -
 , -
 , -
 , -
 . -
 $\langle -040 \rangle$. $\langle . \dots \rangle$ (. -
) .
 ,
 ,
 .



[5].
 ()
 () « »
 « »
 -1 ()
 ()
 ()
 (.1). () -10
 ()



. 1.

(5)

(. 2).

(4)



().

(2)

L,

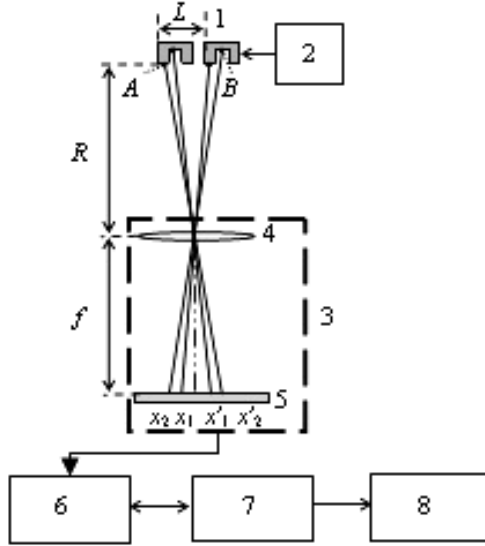

2.
 1.
 2.
 3.
 4.
 5.
 6.
 7.
 8.

()

(7),

(8),

$$R(\Delta x, \Delta y) = \frac{\sum_{x,y} (I_1(x, y) - \bar{I}_1)(I_2(x + \Delta x, y + \Delta y) - \bar{I}_2)}{\sqrt{\sum_{x,y} (I_1(x, y) - \bar{I}_1)^2 \sum_{x,y} (I_2(x + \Delta x, y + \Delta y) - \bar{I}_2)^2}}$$



$$\bar{I}_n = \frac{\sum_{x,y} I_n(x,y)}{x_{\max} y_{\max}}, \quad (1)$$

$I_1 \cdot$; $I_2 \cdot$
 ; $x_{\max}, y_{\max} \cdot$
 ; $x, y \cdot$ -
 ; $\bar{I}_1, \bar{I}_2 \cdot$
 ; $n = 1, 2$ [6; 7].

(1) $x = \hat{\theta}_1$ R
 :

$$R = \frac{f \cdot L}{\Delta x}, \quad (2)$$

$L \cdot$, $f \cdot$ R_B
 2 $\hat{\theta}_2$

(1) $x = \hat{\theta}_2$ R
 :

$$R = \frac{f \cdot L}{\Delta x}. \quad (3)$$

$$(R = R \hat{\theta} R)$$

R_i : i -
 D_i H_i :

$$H_i = \frac{R_i \cdot y_i}{f}, \quad D_i = \frac{R_i \cdot x_i}{f}, \quad (4)$$



$$\alpha = \arctg \left(\frac{X_2 - X_1}{Y_2 - Y_1} \right), \quad (5)$$

X_1, Y_1
 $, X_2, Y_2$

()

5472×3648

22,5×15

$$n = \frac{x}{a} = \frac{22,5}{5472} = 4 \times 10^{-4} (), \quad (6)$$

n
 x
 a

4×10^{-4}



« » -
: ; (, , -
); (, ,);
, ;
/ ; / -
, (. 3).

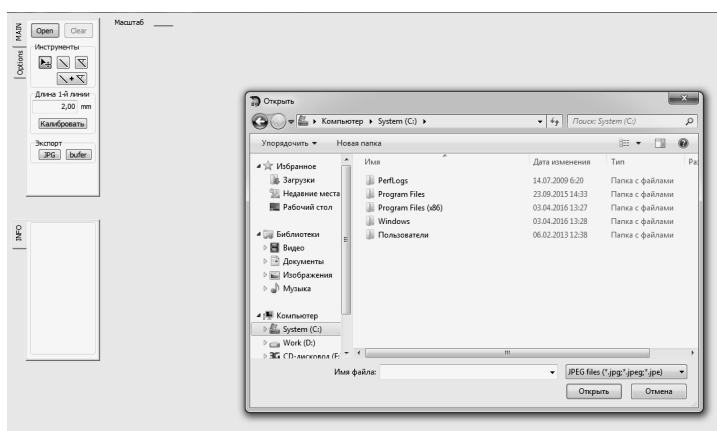

. 3. « »

« » () « » ()
(. 4). (« »)

« ».

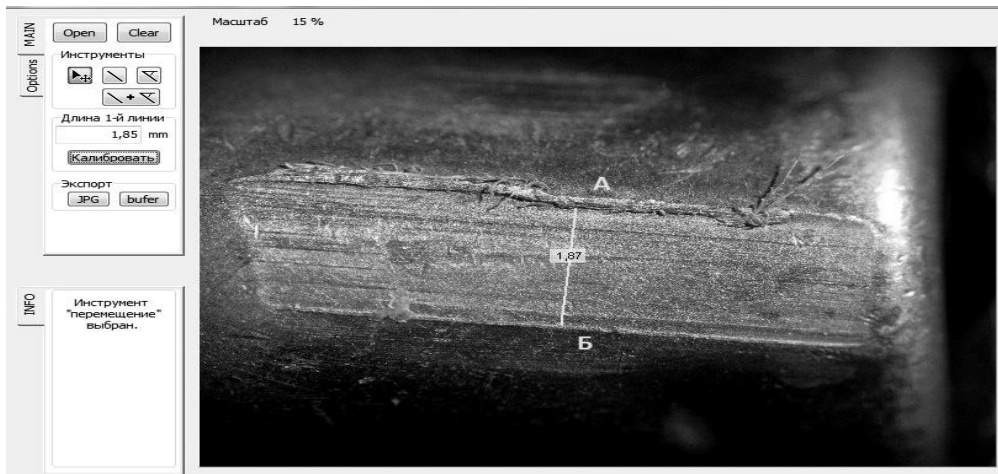

. 4.

5

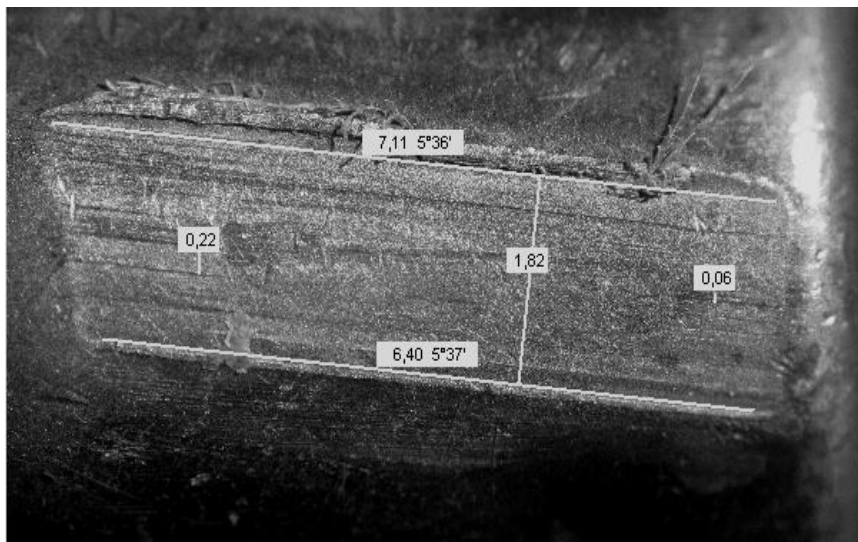

. 5.

()



),
« » (
5
220 60
6 7
-70-18

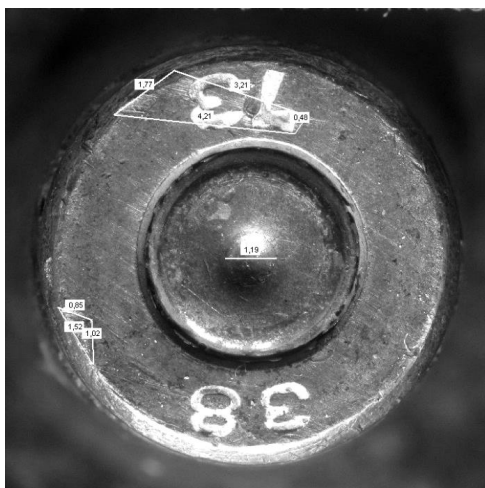

. 6.

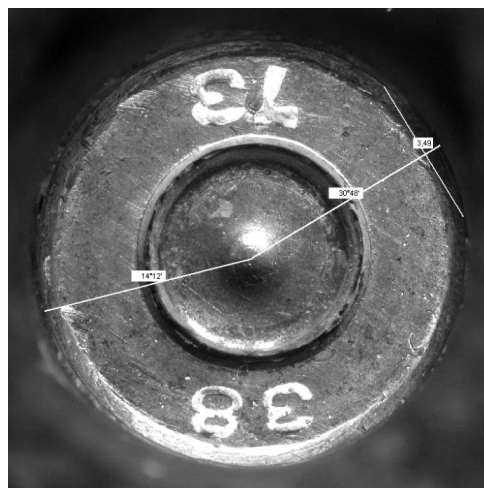

. 7.



(. 8). , ,
 $R = 15,20$,
390 ($R = 15,20 \cdot 14,81 = 0,39$),
 $R = 14,38$. 330
($R = 14,38 \cdot 14,05 = 0,33$).

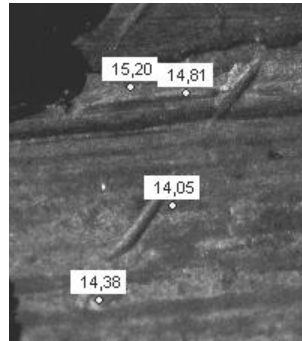

. 8.

«.jpg»

[6; 7].

()

1.

2.



	-
	-
1.	-
	//
. 2012. 4 (32). . 26- 34.	-
2.	-
	: . õ - . :
12.00.12 / , 2015.	-
3.	-
	(.)
∴ , 1973.	-
4.	-
/ ∴ , 1961.	-
5.	-
	//
. 2005. 1 (9). . 160- 163.	-
6.	-
	/ . . [.] //
. 2015. 1. . 46- 51.	-
7.	-
	:
. 1(108). : . . , . . , . . ,	10918: G 01C3/00 (2006.01);

References

1. Kokin A. V. Diagnostirovanie sposoba izgotovlenija stvola narezного ognestrel'nogo oruzhija po ego sledam na vystreljannyh puljah // Sudebnaja jekspertiza. 2012. 4 (32). S. 26- 34.
2. Kokin A. V. Konceptual'nye osnovy kriminalisticheskogo issledovanija narezного ognestrel'nogo oruzhija po sledam na puljah: dis. õ d-ra jurid. nauk: 12.00.12 / A. V. Kokin. M., 2015.
3. Stashenko E. I. Otozhdestvlenie kanala stvola ognestrel'nogo oruzhija po vystrelennoj pule (mehanizm obrazovanija sledov i ustojchivost' priznakov). M.: VNIISJe MJu SSSR, 1973.
4. Komarinec B. M. Identifikacija ognestrel'nogo oruzhija po vystrelennym puljam / otv. red. V. S. Mitrichev. M.: VIJuN MJu SSSR, 1961.
5. Artjushin A. A., Packevich A. P. Ispol'zovanie informacionnyh tehnologij pri proizvodstve sudebno-ballisticheskikh jekspertiz // Vestnik Akademii MVD Respubliki Belarus'. 2005. 1 (9). S. 160- 163.



6. Izmerenie parametrov sledov polej narezov na puljah s ispol'zovaniem korrelyacionnoj obrabotki cifrovyh izobrazhenij / V. L. Kozlov [i dr.] // Sudebnaja jekspertiza Belarusi. 2015. 1. S. 46- 51.

7. Izmeritel' vysot nerovnostej profilja i linejnyh harakteristik mikrosledov na ob'ektah issledovanija kriminalisticheskikh jekspertiz: patent Respubliki Belarus' na poleznuju model' 10918: MPK G 01C3/00 (2006.01); bjul. 1(108). Avtory: V. L. Kozlov, A. S. Rubis, E. A. Lappo, A. S. Vasil'chuk.

© , 2018



A.Yu. Butyrin,

Head of the Laboratory of Construction Forensics the Russian Federal Center of Forensic Science of the Ministry of Justice of the Russian Federation, Doctor of Juridical Sciences;

I. A. Danilkin,

Deputy chief of the expert and criminalistic center of General Directorate of Ministry of Internal Affairs Russia across Moscow · the head of department construction technical expertizes, Candidate of Juridical Sciences

PRODUCTION OF LEGAL CONSTRUCTION TECHNICAL EXPERTISES WITHIN THE CONDITIONS OF LACK OF BASIC DATA

The article describes essential issues of investigation of economic crimes in the area of construction under the circumstances, which must be explored within joint activity of investigators and building experts; the directions and features of use of special construction and building-technical knowledge are defined.

The authors focus on the possibilities of investigators, available methods and technical means of knowledge, skills of their application, which are insufficient for identifying the facts, significant for criminal case, identification of the hidden interactions, properties, signs of the explored objects and the solution of other problems of investigation of economic crimes in the field of construction. It refers to identifying types, volumes, qualities and costs of actually performed construction and special works on construction, repairing (reconstruction, restorations) construction objects on the basis of which the material damage · the qualifying sign of the considered criminal actions is established.

On the basis of authorsqpractical experience the article contains recommendations about the organization of interaction between investigators and building experts in complicated investigative cases within the lack of basic data necessary for production of construction technical expertises.

Key words: legal construction technical expertise, investigation, special construction technical knowledge, lack of basic data.

* * *



, -
 , -
 . -
 , -
 , -
 (. 159) -
 (. 160), (. 201), -
 (. 285). -
 , -
 , -
 , -
 * -
 , -
 , -
 [1, . 30]. -
 (), -
 [2]. -
 , -
 . -
 , -
 , -
 . -



() ,
;
() ,
),
;
, , ,
,
,
(- ,),
, ,
() . , ,
, (, - , - ,
- .) .
, ()
, , ,
() .
(,)
, ()
() ,



.
 ()
 ,
 ,
 .
 .
 -
 .
 ()
)
 ,
 .
 ,
 .
 ,
 .
 ()
 ,
 ()
 .
 .

: ()
 (), , ()
 .
 .
 ()
 , ()
 ,
 .



()

.

-

,

,

-

* « »

-

-

,

.

1. . . . - //
. 2017. 2 (50). . 29- 35.

2. - -
: . 31 2001 . 73- . - -
« ».

References

1. Butyrin A. Ju., Danilkin I. A. Problemy opredelenija rynočnoj stoimosti ob'ektov nedvizhimosti v processe dokazyvanija po ugovolnym delam // Sudebnaja jekspertiza. 2017. 2 (50). S. 29- 35.
2. O gosudarstvennoj sudebno-jekspertnoj dejatel'nosti v Rossijskoj Federacii: feder. zakon ot 31 maja 2001g. 73-FZ. Dostup iz sprav.-pravovoj sistemy «Kon-sul'tantPljus».

©, 2018

* * *



(XIX XX . -

E. Henry [2]. , -

(« » « -

») .

, « ».

n^m , n . (2),

m . (10).

($2^{10} = 1024$), -

» « , « » « » . -

(»), -

» , -

« » , -

[3], -

, (-

) , -

() , -

- (-

« - » . -

20 2016 .). : , , -

, -

(, , , -

), (-

, (-

).

, -

H. Poll H. Kirchmajr XX . [4].



(
,)
(0 5, 6)
0 0(
, 0 1, 0 2, 0 3, 0 4, 0 5, 1 0, 1 1, 1 2, 1 3,
2 0 . .
)
36 (6 6).
(0 1) 0 5, 0 4. (3 5),
- ,
:
[5].
« » .
() (4):
1 4 , 2 3 , 3 2 ,
4 1 (36
, 32).
,
,
,
(
,)
()



«А» «L», «А» «LW», «AL» «W». «А» «W», -

- ' . , , -

- [8- 11] (-

, , -

, , -

, , -

, , -

($p < 0,08$), ($p > 0,05$), -

(), () () , «a-b»,

«b-c» «c-d» [5; 7]), (,),

27 (3³).

($p < 0,05$), (« - - », « - - ») 8- 9

« » (,). -

: , «b-c» (, -

,) , «c-d» (-

). « » -

(3) ó

6 (-

n!, n · , ! · -

1 n).



«а-б». «с-д». «b-c»
 «а-б». «b-c». «с-д»
 («с-д»).
 «b-c». «а-б». «с-д» («с-д», ,).

7
 9
 [12- 14].

», « »
 [15],

()
 (1) (0) A, Lr, Lu, Lw W (5),
) 0 4 (5 2)
 5 2 5 (50) 30 .
 2 270).

(p<0,05) ().
 : W 1 0 (12
), Lu 1 0 (9), Lu 0 0 (4).
 : Lu 0 4 (10), Lu 0 4
 (10), Lu 0 3 (9), W 0 3 (6).



(,) . A W ,
 « 20 (5! / (5 - 2)! = 120/6) (n! / (n - m)! , n .
 » ; , m .) . ,
 2 270) .
 : A₁W₂ · 12 , A₁W₃ · 3, A₁W₄ · 15,
 A₁W₅ · 1, A₂W₃ · 4, A₂W₄ · 38, A₂W₅ · 10, A₃W₄ · 19, A₃W₅ · 7, A₄W₅ · 1,
 A₂W₁ · 31, A₃W₁ · 21, A₄W₁ · 5, A₅W₁ · 1, A₃W₂ · 6, A₄W₂ · 0, A₅W₂ · 1,
 A₄W₃ · 0, A₅W₃ · 0, A₅W₄ · 2. (A₄W₂, A₄W₃
 A₅W₃), 6 (A₁W₃, A₁W₅, A₄W₅, A₅W₁, A₅W₂ A₅W₄) .
 , 9 165 (5 %).
 , 20 · 30
 (A₂W₄, A₃W₄, A₂W₁ A₃W₁).
 W- ,
 (A- ,
).
 (A₄W₂, A₄W₃ A₅W₃), « » (p<0,01).
 A- ,
 W- ,
 ,
) .
 :
 () ,
 . , . ,
 (8,7,
): 2,7; 4,5; 1,5.
 · 18,2.
 A₂A₃Lu₄ 11,1 (
 9 18, 11) .
 ,
 ;
 ;



1. 2006.
2. , 1941.
3. , 2004.
4. , 1966.
5. , 2008.
6. , 1986.
- 7.
8. « » , 2006. . 158- 161.
9. // . 2004. 4. . 42- 48.
10. // - . 2008. 3.
- 4 (48). . 67- 80. // . 2016.



11. . . . : ò ,
2006.
12. . . . , - -
- // XXI . 2017. . 19. 10. . 285- 288.
13. . . . , // -
- . 2015. 6. . 56- 59.
14. . . . , - -
- // 2017. 1 (49). . 19- 29.
15. : ,
1973.

References

1. Anderson Dzh. Diskretnaja matematika i kombinatorika. M.: Vil'jams, 2006.
2. Lokar Je. Rukovodstvo po kriminalistike. M.: NKJu SSSR, 1941.
3. Avdejchik O. S. Raspredelenie zavitkovykh uzorov papilljarnyh linij na nogtevyh falangah pal'cev ruk. Pskov: Pskov-Infopress, 2004.
4. Gladkova T. D. Kozhnye uzory kisti i stopy obez'jany i cheloveka. M.: Nauka, 1966.
5. Bozhchenko A. P., Popov V. L., Zaslavskij G. I. Dermatoglifika pri identifikacii lichnosti: ucheb. posobie. Sankt-Peterburg: Jurid. centr, 2008.
6. Guseva I. S. Morfogenez i genetika grebeshkovej kozhi cheloveka. Minsk: Belarus', 1986.
7. Bozhchenko A. P. K voprosu o vozmozhnosti reshenija jekspertnoj zadachi ustanovlenija celogo po chastjam na osnove analiza shodstva daktiloskopicheskikh priznakov simmetrichno raspolozhennykh uchastkov grebeshkovej kozhi // Materialy sbora rukovodjashhego sostava GJeU MO RF / pod obshh. red. prof. V. V. Kolkutina. SPB: Izd-vo «Na strazhe rodiny», 2006. S. 158- 161.
8. Bozhchenko A. P. Vozmozhnosti opredelenija identifikacionno znachimyh priznakov cheloveka posredstvom analiza dermatoglificheskikh struktur pal'cev ruk // Problemy jekspertizy v medicine. 2004. 4. S. 42- 48.
9. Bozhchenko A. P. Sudebno-medicinskoe i kriminalisticheskoe znachenie belyh linij papilljarnyh uzorov pal'cev ruk // Jekspert-kriminalist. 2008. 3. S. 25- 29.
10. Bozhchenko A. P. Osobennosti stroenija papilljarnyh uzorov pal'cev ruk, obuslovlennye ih anatomicheskoj lokalizaciej // Sudebnaja jekspertiza. 2016. 4 (48). S. 67- 80.
11. Sidorenko A.G. Vozmozhnosti ladonnoj dermatoglifiki pri sudebno-medicinskoj identifikacii lichnosti: avtoref. dis. ò kand. med. nauk. M, 2006.



12. Bozhchenko A. P., Gomon A. A. Rasovo-diagnosticskie osobennosti kombinatoriki tipov papilljarnyh uzorov pal'cev ruk i ih sudebno-meditsinskoe znachenie // Zdorov'e i obrazovanie v XXI veke. 2017. T. 19. 10. S. 285- 288.
13. Bozhchenko A. P., Rigonen V. I. Osobennosti dermatoglificheskoj konstitucii russkih Respubliki Karelija // Uchenye zapiski Petrozavodskogo gosudarstvennogo universiteta. 2015. 6. S. 56- 59.
14. Bozhchenko A. P., Rigonen V. I. Differencial'no-diagnosticskie osobennosti papilljarnyh uzorov pal'cev ruk russkogo i nekotoryh sredneaziatskih narodov // Sudebnaja jekspertiza. 2017. 1 (49). S. 19- 29.
15. Fokina A. A. Identifikacija lichnosti po papilljarnym uzoram ruk s primeneniem matematicheskikh metodov issledovanija. Kiev: RIO MVD USSR, 1973.

© , 2018

« » (.)

5 000



P. M. Koshmanov,

Head of the Training and Scientific Complex of Expert Criminalistics Activities
of the Volgograd Academy of the Ministry of Interior of Russia,
Candidate of Juridical Sciences, Associate Professor;

M. P. Koshmanov,

Candidate of Juridical Sciences, Associate Professor

V. G. Komnatin,

Forensic Expert, Center for Legal Decisions Sovetnik, LLC, Moscow

**A FLOURISH IN THE COMPLETION PHASE OF STRUCTURING
A SIGNATURE, ITS SIGNIFICANCE AND FUNCTIONS**

The article is based on the authors' experimental examination comprising 5,000 signatures of different individuals. One of the main purposes of this examination is to determine the list (range) of functions typical for a flourish as one of the main elements of a signature. As a result of this experiment, it is found that the content of each function has its own specific features and plays a certain role in a signature, while a set of functions individualizes it and enhances its protection from forgery. The significance of functions of a flourish is as follows:

- making a signature structure complete and accomplished;
- increasing the level of identification informativeness of a signature;
- determining the maximum level of automatism of movements in a signature handwriting of any signer;
- enhancing protection of a signature from forgery.

Each of the functions of a flourish in signatures is accompanied by a detailed description and a visual illustration. Besides, the authors give their own extensive definition of a flourish based on the results of the conducted examination. The information represented in the article is not sufficiently considered in forensic literature. That is why, in the authors' opinion, it will be useful for theory as well as for practice of forensic handwriting examination.



Key words: experimental examination, functions of a flourish, signature, graphical tracing, constructional constituents of a signature, level of identification informativeness of a flourish, ways of structuring a flourish.

[1, . 306- 310; 2, . 218- 220; 3, . 289- 390; 4, . 16, 17; 5, . 28].

4 000

1 500

10 000

[6].

5 000

1.

(28 %)

(. 1).

(), « »



)
Ольга Леонидовна

)
Александр Владимирович

)
Ольга Леонидовна
Александр Владимирович
Ольга Леонидовна

1. ;) () ;

2.

(,) » [7, . 16].

[8; 9].

(5 000)



[10, . 95- 106].	-
« » ()	-
« »	-
: 2 12, [11, . 85].	-
(. 2).	-
(. 2).	-
3.	-
[12, . 16, 17].	-

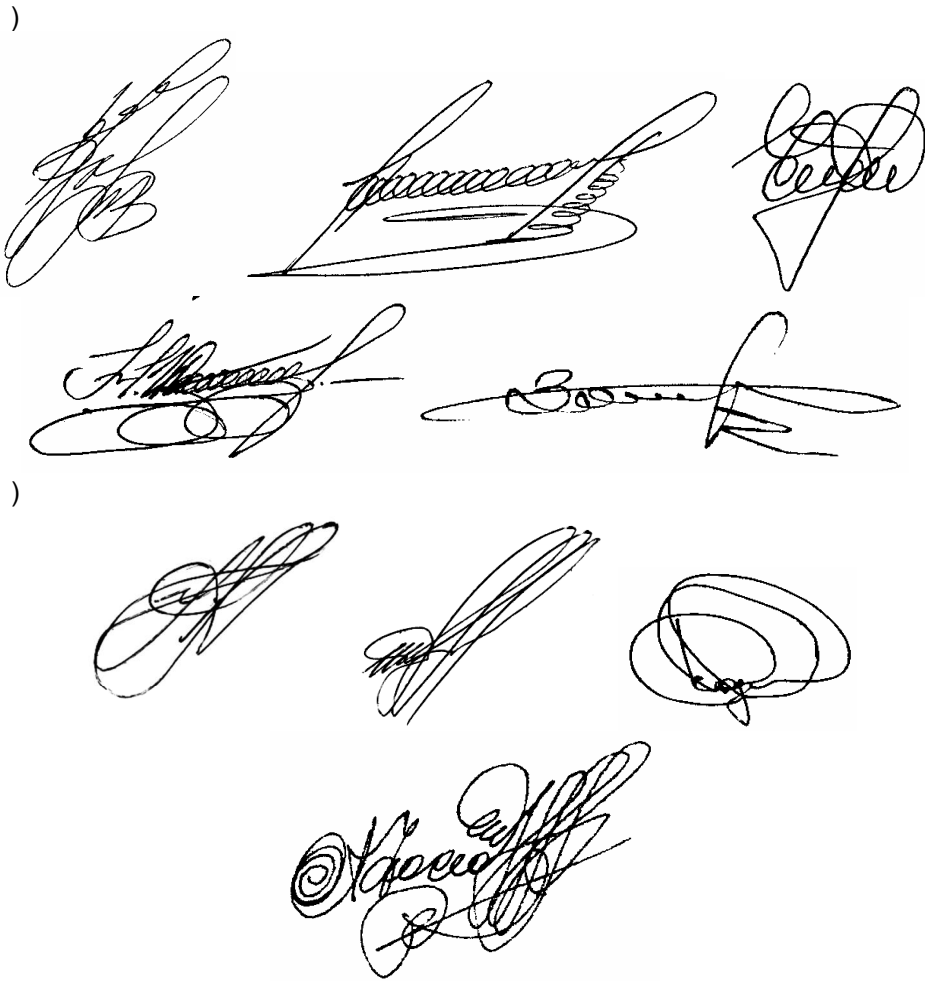

.2.

:)
;)



« »

[13, . 54],

()

1) :

2) -

[14],

« ».

« »



« »
 ().
 ().
 »
 4.
 » [15, . 25].
 4 :
 ()
 () ;
 » [16].
 ()



)

Маслов *А. А.* *С. С. Сидоров*

)

Сидоров *А. А.* *С. С. Сидоров*

)

Сидоров *А. А.* *С. С. Сидоров*

.3.

:)

;)

;)



[Handwritten signature]

[Handwritten signature]

)

)

.4.

,

;

:)

;

)

,

-

.

-

,

,

;

,

(

)

.

1.

. . .

//

-

:

. .,1961. .6. 7. .303- 357.

2.

//

.

2-

. ., 1965. .1.

3.

-

/

-

[.]. ., 1971. .2. .269- 331.

4.

-

-

. ., 1966. .1.

5.

..

-

-

:

, 2013.

6.

..

-

//

.2010. .3. .40- 45.

7.

..

..

..

-

.

//

-

.2009. 1. .15- 20.

8.

..

..

:

, 2000.



9. , 2004. -
10. //
- . 2014. 3. . 95- 108.
11. //
2012. 2. . 77- 87.
12. - //
- : , 1996. . 1. -
13. - //
14. //
- . 2012. 2. . 59- 65. -
15. / [.]// -
2016. 1. . 22- 26.
16. //
- . 2015. 2. . 10- 14. -
17. / -
- [.]// . 2016. 1. . 96- 107. -
18. XIX- XX : // -
- . 2014. 2. . 117- 129. -
19. // -
- , 1951. . 105- 115. -

References

1. Orlova V. F. Metodika issledovanija podpisov // Teorija i praktika kriminalisticheskogo jekspertizy: jekspertiza pocherka. M., 1961. Sb. 6- 7. S. 303- 357.
2. Tehnika jekspertizy dokumentov // Graficheskaja jekspertiza dokumentov. 2-e izd. M., 1965. Vyp. 1.
3. Lipovskij V. V. Sudebno-pocherkovedcheskaja jekspertiza / otv. red. A. I. Man'cvetova [i dr.]. M., 1971. Ch. 2. S. 269- 331.
4. Sudebno-pocherkovedcheskaja jekspertiza maloob'emnyh pocherkovykh ob'ektov. M., 1966. Vyp. 1.
5. Koshmanov P. M., Koshmanov M. P. Jekspertno-kriminalisticheskoe issledovanie sovremennyh podpisov: ucheb. posobie. Volgograd, 2013.



6. Koshmanov M. P., Koshmanov P. M., Shnajder A. A. Udostoveritel'naja i zashhitnaja funkcii podpisi // Notarius. 2010. Vyp. 3. S. 40- 45.
7. Koshmanov P. M., Koshmanov M. P., Shnajder A. A. Identifikacionnaja informativnost' podpisi - osnova otozhdestvlenija ee ispolnitelja // Jekspert-kriminalist. 2009. 1. S. 15- 20.
8. Koshmanov P. M., Koshmanov M. P. Klassifikacii identifikacionnyh priznakov v pocherkovedcheskoj jekspertize: ucheb. posobie. Volgograd, 2000.
9. Koshmanov P. M., Koshmanov M. P. Priznaki pocherka v jekspertno-kriminalisticheskom issledovanii: ucheb. posobie. Volgograd, 2004.
10. Koshmanov P. M., Koshmanov M. P., Vilkova N. A. Differenciacija sovremennyh podpisej po stepeni ih identifikacionnoj informativnosti // Sudebnaja jekspertiza. 2014. 3. S. 95- 108.
11. Koshmanov P. M., Koshmanov M. P., Vilkova N. A. Konstruktivnoe stroenie sovremennyh podpisej: svoeobrazie vypolnenija, identifikacionnaja informativnost' osnovnyh chastej i sostavnyh jelementov // Sudebnaja jekspertiza. 2012. 2. S. 77- 87.
12. Sudebno-pocherkovedcheskaja jekspertiza maloob'emnyh pocherkovykh ob'ektov // Obshhie principy issledovanija maloob'emnyh pocherkovykh ob'ektov: metod. posobie dlja jekspertov / pod red. V. F. Orlovoj. M., 1996. Vyp. 1.
13. Sudebno-pocherkovedcheskaja jekspertiza maloob'emnyh pocherkovykh ob'ektov // Metodika issledovanija podpisi / nauch. red. V. F. Orlova. M., 1997. Vyp. 3.
14. Kovalev P. A. K voprosu o chastnyh priznakah pocherka // Vestnik Barnaul'skogo juridicheskogo instituta MVD Rossii. 2012. 2. S. 59- 65.
15. Original'nost' konstruktivnogo stroenija podpisej: ponjatie i sostavljajushhie strukturnye jelementy / P. M. Koshmanov [i dr.] // Jekspert-kriminalist. 2016. 1. S. 22- 26.
16. Koshmanov P. M., Koshmanov M. P., Vilkova N. A. Differenciacija sovremennyh podpisej po stepeni original'nosti ih konstruktivnogo stroenija // Jekspert-kriminalist. 2015. 2. S. 10- 14.
17. Tipy sovremennyh podpisej rossijskih grazhdan kak kriterii opredelenija stepeni original'nosti konstruktivnogo stroenija / P. M. Koshmanov [i dr.] // Sudebnaja jekspertiza. 2016. 1. S. 96- 107.
18. Koshmanov P. M., Koshmanov M. P., Vilkova N. A. Podpisi rossijskih grazhdan rubezha XIX- XX vekov: ih konstruktivnoe stroenie // Sudebnaja jekspertiza. 2014. 2. S. 117- 129.
19. Levi A. A. Zashhita dokumentov ot podloga kak sredstvo preduprezhdenija hishhenij socialisticheskoj sobstvennosti // Voprosy sovetskoj kriminalistiki. M., 1951. S. 105- 115.

© , 2018



A. V. Krainsky,

Lecturer at the Department of Traceology and Ballistics
of the Training and Scientific Complex of Expert Criminalistics Activities
of the Volgograd Academy of the Ministry of Interior of Russia

COMPREHENSIVE APPROACH WHILE EXAMINATION OF SUDORAL AND FATTY SUBSTANCES

One of the key tasks set before forensic services, both domestic and abroad, is the cooperation with research and development centers as well as public agencies aiming to improve earlier applied and develop new comprehensive methods. Therefore, it is required to examine and analyze them.

This article highlights possibilities of comprehensive approach while examination of latent fingerprints left at a place where crime occurred to obtain supplementary evidentiary information required for criminal investigation. Application of NMR spectroscopy, infrared spectrometry and mass-spectrometric studies when combined with visual and optical methods as well as DNA analysis allows performing various diagnostic and identification tasks. In particular, based on analysis of qualitative and quantitative composition of sudoral and fatty substance, it makes possible to detect drugs consumption, medications taking, and human diseases as well as to detect contact with certain substances (explosives, drugs etc.).

Key words: forensic investigation, dactyloscopy, sudoral and fatty prints, metabolic products, spectrometry, comprehensive examination approach.

.....



(. 1).

1

[1; 2]

()	/ ,	()	
	1,45 200 3,5 3,15 0,75	ō ō	. . . ō ō
()	/ ,	()	
	3 500 3 300 200 3,5 2 10 1,4 0,069 0,069	ō ō ō ō
()	% ,	()	% ,
	30- 40 15- 25 1- 3 - 25- 30

, , -
 :
 () () ;
) () ;

(. 1) [3].

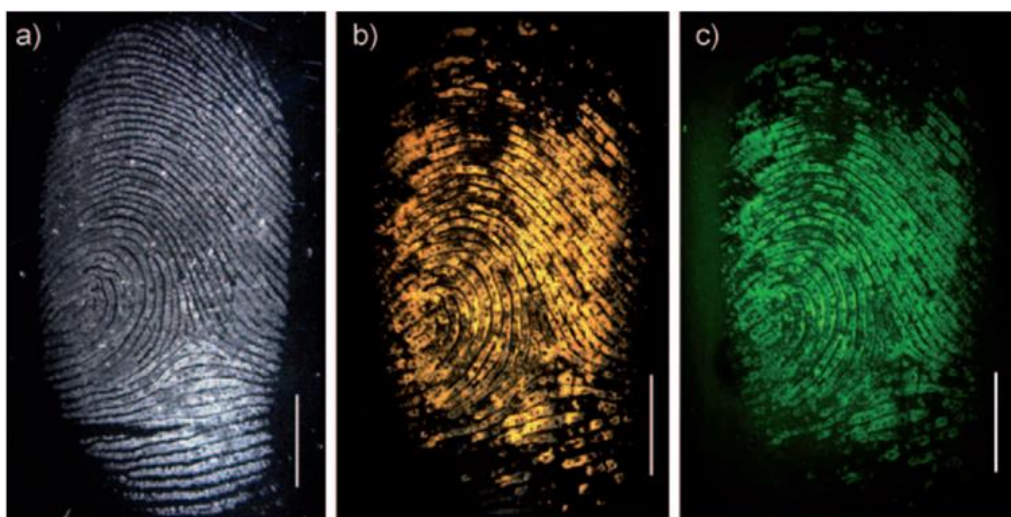

. 1.

[3]:

)
c) -

; b)

;

[4- 7]:



(, ,);
2015 . ,
(), DESI (Desorption Electrospray
Ionization).
[8].

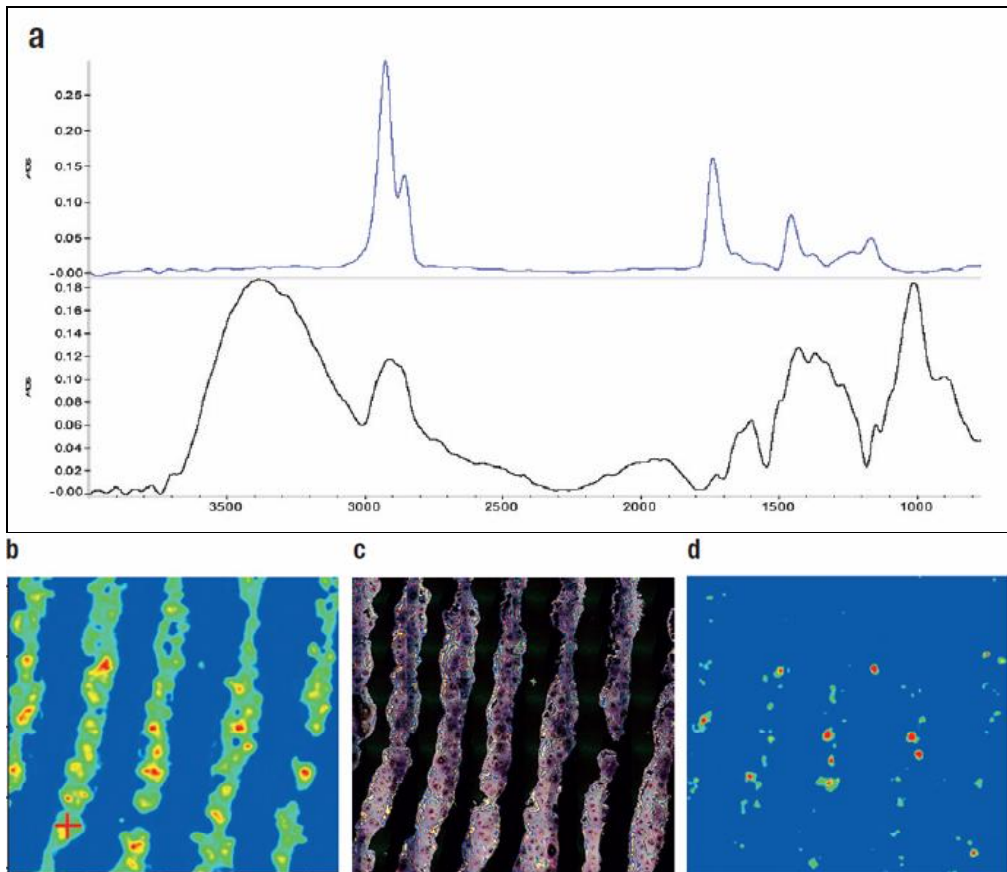

2.
a) - ;
b) ; c) ;
d) [9]



(. 2) [9].

()

82 %

84 %.

89 %,

(. 3) [10].

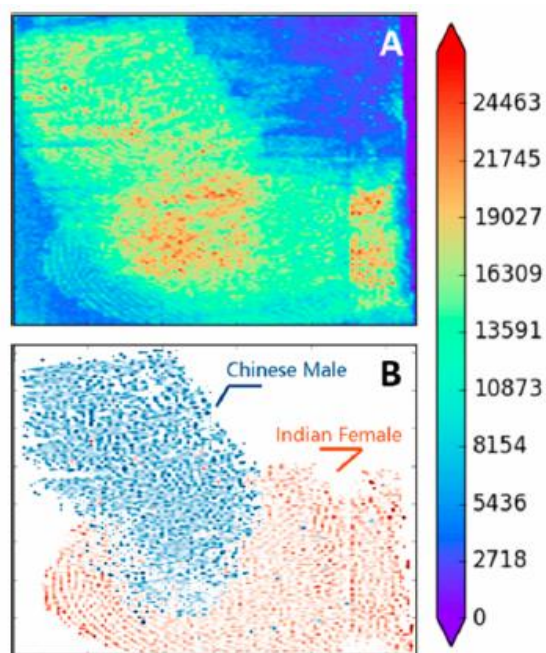

. 3.

)

;)

: с

[10]



2 [11; 12].
2

	(SPR)	±	
		±	
		+	
		+	
	1,8- (DFO)	-9-	
		+	
		+	
		+	
	+		
	+	6G	
	+	6G +	

3 2008 . 242 « ».

« »

[11; 13; 14].



1. / . . , . . , : - , 2011.
2. Cadd S. et al. Fingerprint composition and aging: a literature review // *Science & Justice*. 2015. . 55. . 4. . 219- 238.
3. Hazarika, Pompei, Sue M. Jickells, Kim Wolff a David A. Russell. Imaging of Latent Fingerprints through the Detection of Drugs and Metabolites. *Angewandte Chemie International Edition*. 2008. 47(52). 10167- 10170 [cit. 2017-03-01]. DOI: 10.1002/anie.200804348.
4. Otisky prst na vás te vyzradí i to, zda berete drogy a co jíte. URL: https://technet.idnes.cz/vedci-vylepsili-analyzu-otisku-prstu-najdou-v-nich-stopy-drog-i-jidla-1ky-/veda.aspx?c = A110805_172521_veda_mla (: 30.10.2017).
5. / : , 2003.
6. Chemical fingerprinting and quantitative analysis of a Panax notoginseng preparation using HPLC-UV and HPLC-MS / H. Yao [et al.] // *Chinese medicine*. 2011. . 6. . 1.
7. Fingerprinting analysis of fresh ginseng roots of different ages using H-NMR spectroscopy and principal components analysis / Y. S. Shin [et al.] // *Archives of pharmacal research*. 2007. . 30. . 12. . 1625- 1628.
8. Rapid detection of cocaine, benzoylecgonine and methylecgonine in fingerprints using surface mass spectrometry / Bailey, Melanie J., Robert Bradshaw, Simona Francese [et al.]. *The Analyst*. 2015. 140(18). 6254- 6259. [cit. 2017-03-01]. DOI: 10.1039/C5AN00112A.
9. FT-IR Microspectroscopy in Forensic and Crime Lab Analysis. URL: <https://tools.thermofisher.com> (: 30.10.2017).
10. Zhenpeng Z a Richard N. ZARE. Personal Information from Latent Fingerprints Using Desorption Electrospray Ionization Mass Spectrometry and Machine Learning. *Analytical Chemistr* . 2017. 89(2). 1371 [cit. 2017-03-04]. DOI: 10.1021/acs.analchem.6b04498.



11. Summary of Experiments Investigating the Impact of Fingerprint Processing and Fingerprint Reagents on PCR-based DNA Typing Profiles / T. Spear [et al.]. 2015.
12. Summary of Experiments Investigating the Impact of Fingerprint Processing and Fingerprint Reagents on PCR-based DNA Typing Profiles / T. Spear [et al.]. 2015.
13. Summary of Experiments Investigating the Impact of Fingerprint Processing and Fingerprint Reagents on PCR-based DNA Typing Profiles / T. Spear [et al.]. 2015. 2-2.
14. Summary of Experiments Investigating the Impact of Fingerprint Processing and Fingerprint Reagents on PCR-based DNA Typing Profiles / T. Spear [et al.]. 2016. 59. 2. 14-18.

References

1. Daktiloskopicheskaja jekspertiza: sovremennoe sostojanie i perspektivy razvitija / V. E. Kornouhov, Ju. Ju. Jaroslav, T. V. Jarovenko. M.: Norma: INFRA-M, 2011.
2. Cadd S. et al. Fingerprint composition and aging: a literature review // Science & Justice. 2015. T. 55. 4. S. 219- 238.
3. Hazarika, Pompei, Sue M. Jickells, Kim Wolff a David A. Russell. Imaging of Latent Fingerprints through the Detection of Drugs and Metabolites. Angewandte Chemie International Edition. 2008. 47(52). 10167- 10170 [cit. 2017-03-01]. DOI: 10.1002/anie.200804348.
4. Otisky prst na vás te vyzradí i to, zda berete drogy a co jíte. URL: https://technet.idnes.cz/vedci-vylepsili-analyzu-otisku-prstu-najdou-v-nich-stopy-drog-i-jidla-1ky-veda.aspx?c = A110805_172521_veda_mla (data obrashhenija: 30.10.2017).
5. Moiseeva T. F. Kompleksnoe issledovanie potozhirovyh sledov cheloveka / pod red. N.P. Majlis. M.: Gorodec, 2003.
6. Chemical fingerprinting and quantitative analysis of a Panax notoginseng preparation using HPLC-UV and HPLC-MS / H. Yao [et al.] // Chinese medicine. 2011. T. 6. 1.
7. Fingerprinting analysis of fresh ginseng roots of different ages using H-NMR spectroscopy and principal components analysis / Y. S. Shin [et al.] // Archives of pharmacal research. 2007. T. 30. 12. S. 1625- 1628.
8. Rapid detection of cocaine, benzoylecgonine and methylecgonine in fingerprints using surface mass spectrometry / Bailey, Melanie J., Robert Bradshaw, Simona Francese [et al.]. The Analyst. 2015. 140(18). 6254- 6259. [cit. 2017-03-01]. DOI: 10.1039/C5AN00112A.
9. FT-IR Microspectroscopy in Forensic and Crime Lab Analysis. URL: <https://tools.thermofisher.com> (data obrashhenija: 30.10.2017).
10. Zhenpeng Z a Richard N. ZARE. Personal Information from Latent Fingerprints Using Desorption Electrospray Ionization Mass Spectrometry and Machine Learning.



Analytical Chemistru. 2017. 89(2). 1371 [cit. 2017-03-04]. DOI: 10.1021/acs.analchem.6b04498.

11. Druzhinin Ju. A., Lashh-Zavada A. Ju. Issledovanie vlijanija sredstv vyjavlenija potozhirovyh sledov ruk na posledujushhee provedenie DNK-issledovanija: metod. rekomendacii. M.: JeKC MVD Rossii, 2012.

12. Summary of Experiments Investigating the Impact of Fingerprint Processing and Fingerprint Reagents on PCR-based DNA Typing Profiles / T. Spear [et al.]. 2015.

13. Starchenko A. V. Sovremennye vozmozhnosti ispol'zovanija metoda genotiposkopii v biologicheskoj jekspertize pri rassledovanii prestuplenij // Izvestija Tul'skogo gosudarstvennogo universiteta. Jekonomicheskie i juridicheskie nauki. 2015. 2-2.

14. Problemy molekularno-geneticheskoj identifikacii potozhirovyh sledov otpechatkov pal'cev cheloveka / T. G. Faleeva [i dr.] // Sudebno-medicinskaja jekspertiza. 2016. T. 59. 2. S. 14- 18.

©, 2018



N. N. Ilyin,

Senior Lecturer of the Criminalistics Department of the Moscow academy
of the Investigative Committee of the Russian Federation,
Candidate of Juridical Sciences

ON THE ROLE OF THE EXPERT EXPERIMENT IN THE PRODUCTION OF JUDICIAL-PORTRAIT EXAMINATION

The author considers the questions connected with carrying out an expert experiment within judicial and portrait examination according to video images. In this article it is about those cases when there is a need for carrying out an expert experiment which as it is represented, can have essential value when checking validity of a conclusion of the expert-portraitist. Besides, the expert experiment isn't considered by some scientists as an independent stage of a research at all.

The expert experiment, according to the author of article, at implementation of identification of the person on signs of appearance is conducted rather seldom, however, if there is a need to check how these or those factors influence display of signs of appearance, he should be seen off. It is represented that by means of the expert experiment conducted by production of judicial and portrait examinations on video materials it is possible to create new conditions for studying and assessment of the revealed signs of elements of appearance of the person under the influence of certain factors. The author is convinced that the expert experiment in judicial and portrait examination according to video images as an independent investigation phase can not be considered as it is sometimes carried out in common and at stages of a separate and comparative research.

Key words: videogram, video, the signs of human appearance, the stage of the expert examination, is judicial-portrait examination, the expert experiment.



.....	1
.....	2
.....	3
.....	4
.....	5
.....	6
.....	7
.....	8
.....	9
.....	10
.....	11
.....	12
.....	13
.....	14
.....	15
.....	16
.....	17
.....	18
.....	19
.....	20
.....	21
.....	22
.....	23
.....	24
.....	25
.....	26
.....	27
.....	28
.....	29
.....	30
.....	31
.....	32
.....	33
.....	34
.....	35
.....	36
.....	37
.....	38
.....	39
.....	40
.....	41
.....	42
.....	43
.....	44
.....	45
.....	46
.....	47
.....	48
.....	49
.....	50
.....	51
.....	52
.....	53
.....	54
.....	55
.....	56
.....	57
.....	58
.....	59
.....	60
.....	61
.....	62
.....	63
.....	64
.....	65
.....	66
.....	67
.....	68
.....	69
.....	70
.....	71
.....	72
.....	73
.....	74
.....	75
.....	76
.....	77
.....	78
.....	79
.....	80
.....	81
.....	82
.....	83
.....	84
.....	85
.....	86
.....	87
.....	88
.....	89
.....	90
.....	91
.....	92
.....	93
.....	94
.....	95



.....

.....

[4, . 22- 49].

.....

.....

.....

.....

[5, . 132, 133].

.....

.....

.....

[6, . 130].

.....

.....

.....

.....

.....

[7].

.....

.....

.....

[8, . 121- 123].

.....

.....

[9].



,
 -
 ,
 -
 ,
 -
 ,
 -
 (,
 -
),
 (-
 ,
 -
).
 -
 , . 2 . 4 . 57
 -
 ,
 -
 « » ,
 -
 (-
 . .).
 ,
 -
 ,
 -
 ,
 (,
 ,
 «__» _____ 2014 . . 3 . 183).
 ,
 -
 ,
 (,
 ,
 ,
 .),
 ,
 -
 :
 -
 (. 1).



. 1.

(,)

..... () (, -)
)

 (-)

 (, , -);
 (, , -)
)

)

 (, -)
 ;

 ()
 ()
)



[8, . 33],

[10; 11].

1. / : [. .], 1972.

2. : , 1979.

3. - : , /

4. « » , 2008.

5. : / [. .]; : , 2000.

6. : , 2002.

7. - :1 / ; - , 1974.

8. : / : , 2015.



9. URL: <http://www.sudexp.org/index/0-312> (: 05.09.2017).
10. URL: <http://ppublishing.org/ru/journals/61/issue/531/articles/173/> . 200- 205 (: 05.09.2017).
11. 2016. 2 (34). . 20- 25.

References

1. Processual'nye i organizacionnye osnovy kriminalisticheskoy jekspertizy: metod. posobie / A. R. Shljahov. M.: [b.i.], 1972.
2. Shljahov A. R. Sudebnaja jekspertiza: organizacija i provedenie. M.: Jurid. lit., 1979.
3. Sudebno-jekspertnoe issledovanie: pravovye, teoreticheskie, metodologicheskie i informacionnye osnovy proizvodstva: monogr. / Ju. G. Plesovskih. M.: IG «Jurist», 2008.
4. Vinberg A. I. Osnovnye principy sovetskoj kriminalisticheskoy jekspertizy. M.: Gosjurizdat, 1949.
5. Kriminalistika: uchebnik dlja vuzov / T. V. Aver'janova [i dr.]; pod red. prof. R. S. Belkina. M.: NORMA, 2000.
6. Zinin A. M., Majlis N. P. Sudebnaja jekspertiza: uchebnik. M.: Zakon i pravo, 2002.
7. Sudebno-ballisticheskaja jekspertiza: ucheb. metod. posobie. Vyp. 1 / B. M. Komarinec; otv. red.: H. M. Taho-Godi. M.: Izd-vo VNIISJe, 1974.
8. Kriminalisticheskaja identifikacija cheloveka po priznakam vneshnego oblika, zapechatlennym na videoizobrazhenijah: monogr. / N. N. Il'in. M.: Jurlitinform, 2015.
9. Slovar' sudebnogo jeksperta. Terminy i ponjatija // Rossijskaja jenciklopedija sudebnih jekspertiz. URL: <http://www.sudexp.org/index/0-312> (data obrashhenija: 05.09.2017).
10. Egel'skij V. A., Kolotushkin S. M. K voprosu o vozmozhnosti identifikacii cheloveka po izobrazheniju jelementov lica cheloveka, ne zakrytoj maskoj // Nauchnye publikacii v izdanijah Avstrii. URL: <http://ppublishing.org/ru/journals/61/issue/531/articles/173/> S. 200- 205. (data obrashhenija: 05.09.2017).
11. Kolotushkin S. M. K voprosu o vozmozhnosti identifikacii cheloveka po izobrazheniju jelementov lica, ne zakrytyh maskoj // Vestnik instituta: prestuplenie, nakazanie, ispravlenie. 2016. 2 (34). S. 20- 25.

© . . , 2018



in some nearby regions of the Russian Federation (the Republic of Altai, Tyva, Buryatia, and the Chita Region) traditional handcrafted locks are also still in use. These locks are distinguished by non-typical design and different numbers of keys to unlock one particular lock which are characterized by various combinations of ledges and deepenings.

A mechanism, a principle of locking, and ways of criminal unlocking and breaking modern locks are widely described in forensic literature. However, there is almost no such data in relation to Mongolian handcrafted locks.

Peculiarities of design and principles of locking Mongolian handcrafted locks are studied. According to results of the analysis of expert practice of their examination, the most common ways of their unlocking and breaking are established. Along with this, possibilities of forensic examination of corresponding traces are determined.

The conducted analysis of design and ways of unlocking Mongolian handcrafted locks allows expanding the possibilities of their diagnostic examination. Reference materials represented by the author can be helpful for officials of forensic subdivisions of territorial agencies of the Ministry of Interior of Russia related to the above mentioned regions to study conditions of crime scene examination as well as to conduct trace evidence examination.

Key words: forensic examination, trace evidence examination, traceology, lock, locking device, examination of locks.

« »
« »
[1].



(, , ,) « » -

, -

. -

1240- , -

, -

. -

, -

. -

, -

. -

, -

1949 . 20 000 , -

. -

, -

[2] (. 1). 5



. 1. , . .

, -

. -

, , , -

(. 2).



. 2.

« », -

(. 3- 4).



. 3.



. 4.



(« »),

()

(.5- 6).

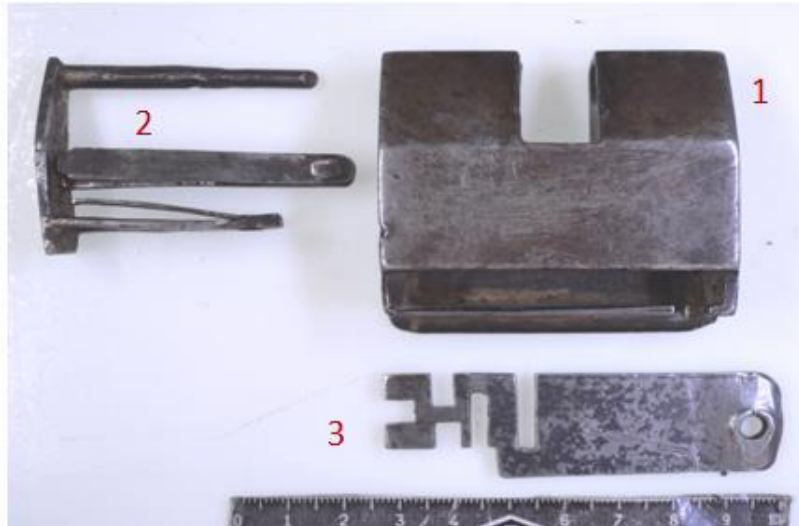

1. .5. :
, 2. , 3.



. 6. :
1. , 2.

(.7).

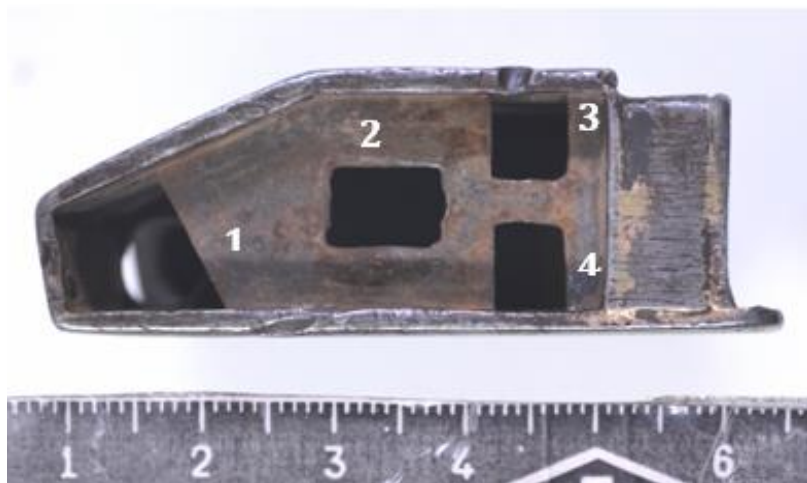

7. :
1. , 2, 3, 4.

(8).

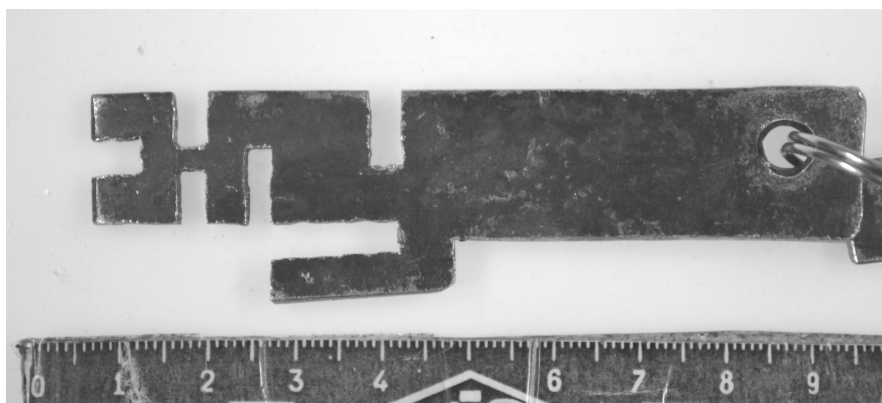

8.



(. 9- 11).



. 9.
1. , 2. , 3.
4. , 5.

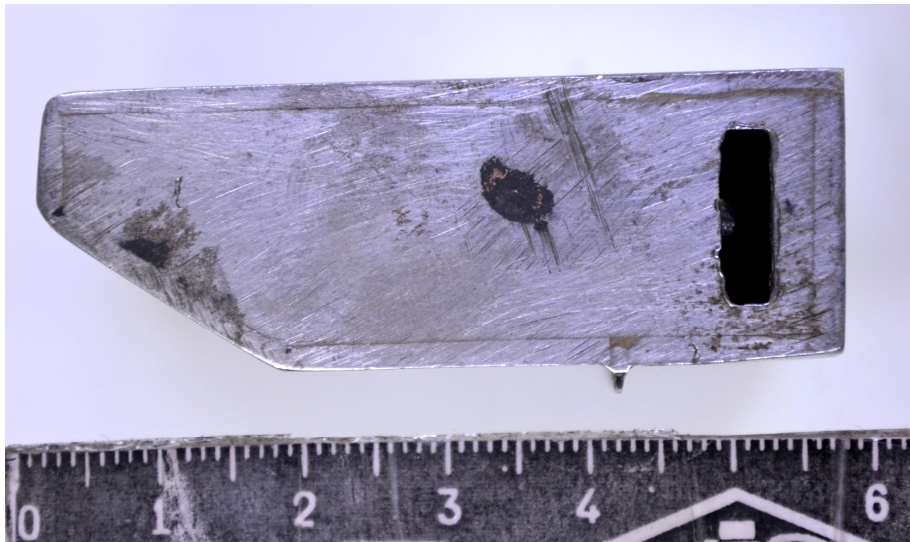

. 10.



1. , -
« » -
(. 13).



. 13.
2. , -
« » -
(. 14).
-
-
-
-
-
-
« -
?»
[4, . 185- 189].



. 14.

1. // . 2013. 1 (33). . 105- 114.
2. FACT.MN // . URL: <http://www.fact.mn/7699.html> (: 26.10.2017).
3. Mongolian national modern art gallery. URL: <http://eng.art-gallery.mn/handicrafts> (: 28.10.2017).
4. : / ; , : , 2002.

References

1. Kitaev E. V. Kriminalisticheskoe issledovanie zamkov, otkrytyh s ispol'zovaniem bamp-metoda // Sudebnaja jekspertiza. 2013. 1 (33). S. 105- 114.



2. FACT.MN // Chuhlyg Onclov. URL: <http://www.fact.mn/7699.html> (data obrashhenija: 26.10.2017).

3. Mongolian national modern art gallery. URL: <http://eng.art-gallery.mn/handicrafts> (data obrashhenija: 28.10.2017).

4. Trasologija i trasologicheskaja jekspertiza: uchebnik / otv. red. I. V. Kantor; V. A. Jarmak, N. Ju. Zhigalov, P. P. Smol'jakov. M.: IMC GUK MVD Rossii, 2002.

© . . ., 2018

* * *



..... ,
« - »
:
?
,
,
.
-
-
-
-
« . -
».
,
-
-
« - » « ».
,
-
:
, « ».
, « ».

V. B. Danilovich,
Chief Forensic Expert Security Department, Public Joint-Stock Company
«MTS-Bank»

**RESEARCH TECHNIQUES FOR CROSSING STROKES:
MYTH OR REALITY?**

The article approaches research techniques for crossing strokes that are comprised of some special methods dealing with specific writing materials used for documents details.

It also provides with historical background, covering period of time from the beginning of the twentieth century till the current days, to development of the research techniques for crossing strokes.

It is stated that research techniques for crossing strokes represent a set of approaches and methods applied in examination of documents and let achieve positive results in completing the task.



The Article insists that nowadays examination of crossing strokes must be held following the formula «certain writing material needs certain examination method».

It is also shows an example of special approach to examination of crossing strokes made with stamp ink and pictures obtained results. The research was made by hardware-software television system «Expert-K» in «peek-a-boo» mode. It is unknown whether the approach in question can be applied to all similar crossings or it is just a singular fact.

Key words: intersecting strokes, research methodology overlapping strokes, inks, shooting against the light.

* * *

« , , « [1, . 383].
- , « - -
» [2, . 111, 112].
- , -
(. 1).



. 1.



1903 . , -
, -
- « , » -
» . « » -
, -
: « -
, -
? , , -
, , , -
, » [3, . 356]. -
« » . . : « -
ō -
» [3, . 360]. , -
, [3, . 361], -
, , -
, -
: -
(,) -
(,) -
? -
1910 . , -
(Osborn) . «Questioned Documents» («
»), 1932 . -
, (. .) [4], -
, -
, , . .



[4, . 163].

60- 70-

[5],

: 1)

; 2)

; 3)

1978 .

»,

: «

[16, . 3].

«

».

80- 90-

50

Millipor ()

(

) [7].

(ILA-120-1)

488 .

700 ,

[8].



2008- 2009 . - -

[9]. - -

2010 . « - -

, », - -

, . . - -

[10]. - -

, - -

(), () , - -

(,) - -

.) , - -

[11, . 7]. - -

2014 . . . () . . - -

() , - -

3 2 . . : « - -

» [12, . 111- 125]. - -

[13, . 107- 166] - -

, - -

, - -

, - -

, - -

, - -

, - -

, - -

() - -

[8; 10]. - -

« - -

/ ». , - -

, - -

() () - -

, - -

, - -

« » - -



« 801 Trodat () . 7011 olop () ,

« » « »?

« : « » (. 2, 3) .



.2. « »



.3. « »

« »

« » (-)

$F1 \cdot a_{0,5} = 385 \cdot 540$)

(. 4, 5) .



4. « »



5. « »

« »

« »

1. ... -

2. // // -

3. « ... (, 26- 27 2017 .). , 2017. »:

4. / ... ; , « ... » . . , 2003.

5. ... , ... , 2002.

6. / , 1932.

7. : - . - / ... , 1971.

8. : ... , 1978.

9. - 3. . 3. / ... , 1993.

10. : ... , ... ,

11. : ... , ... ,

12. : , 2010.



11. -
 12. , 2011. -
 13. , 2014. -
- ., 2014.

References

1. Shvedova N. N. Diskussionnye voprosy praktiki proizvodstva tehniko-kriminalisticheskikh jekspertiz dokumentov pri rassledovanii prestuplenij jekonomicheskoy napravlenosti // Materialy II Mezhdunarodnoj nauchno-prakticheskoy konferencii «Diskussionnye voprosy teorii i praktiki sudebnoj jekspertizy»: informacionnyj bjulleten' (Moskva, 26- 27 oktjabrja 2017 g.). M., 2017.
2. Slovar' terminov i opredelenij kriminalisticheskoy jekspertizy dokumentov / pod obshh. red. A. S. Grigor'eva; MVD Rossii, GUP NPO «Special'naja tehnika i svjaz'». M., 2003.
3. Burinskij E. F. Sudebnaja jekspertiza dokumentov, proizvodstvo eja i pol'zovan e eju: reprint. izd. M., 2002.
4. Potapov S. M. Tehnika issledovaniya dokumentov / per. s nem. raboty A. Sh. Osborna. M., 1932.
5. Issledovanie peresekajushhihsja shtrihov: materialy nauch.-prakt. seminaru / pod red. A. A. Guseva. M., 1971.
6. Viktorova L. N., Safronenko T. I., Jurkov I. S. Issledovanie peresekajushhihsja shtrihov: metod. posobie. M., 1978.
7. Sudebno-tehnicheskaja jekspertiza dokumentov. Osobennaja chast'. Vyp. 3. Gl. 3. Ustanovlenie odnositel'noj davnosti vypolnenija zapisej / RFCSJe. M., 1993.
8. Danilovich V. B., Onishhenko A. A. Issledovanie peresekajushhihsja shtrihov. Ch. 1. Obshhaja shema, metody i chastnye metodiki issledovaniya / RFCSJe. M., 2003.
9. Ustrojstvo dlja osveshhenija dokumentov: patent na poleznuju model' 77442. Avtory: O. Ju. Milovidova, G. N. Sabaev, M. V. Toropova.
10. Danilovich V. B., Pahomov A. V. Issledovanie peresekajushhihsja shtrihov, vypolnennyh razlichnogo roda chernilami: metod. rekomendacii. M., 2010.
11. Toropova M. V. Ustanovlenie posledovatel'nosti nanesenija v dokumentah rekvizitov, vypolnennyh jelektrofotograficheskim sposobom, i rukopisnyh rekvizitov, ottiskov pechatej: metod. rekomendacii. M., 2011.
12. Barinova O. A. Kriminalisticheskoe issledovanie rekvizitov dokumentov, nanesennyh sovremennymi materialami pis'ma: teoreticheskie i prikladnye aspekty: dis. ō kand. jurid. nauk. Volgograd, 2014.



13. Toropova M. V. Kriminalisticheskaja jekspertiza ustanovlenija odnositel'noj davnosti vypolnenija rekvizitov dokumentov: dis. o' kand. jurid. nauk. M., 2014.

© . . ., 2018

..... ,
- ;
..... ,
- ,
5,45- -74 , -105 -74
- -
- -
- -
-74 , -105 -74 5,45-
(0 200) , -
5,45- -
- -
-74 , -105
-74 .
- -
- -



I. A. Chulkov,

Senior Lecturer of the Department of Traceology and Ballistics
of the Training and Scientific Complex of Expert Criminalistics Activities
of the Volgograd Academy of the Ministry of Interior of Russia;

A. S. Kopanev,

Lecturer at the Department in forensic examinations and research
Saint-Petersburg University of the Ministry of Interior of Russia,
Candidate of Juridical Sciences

**PECULIARITIES OF TRACES OF A CLOSE-RANGE GUNSHOT
WHEN FIRING THE 5,45 MM AK-74M, AK-105, AND AKS-74U
ASSAULT RIFLES**

In spite of the fact that in forensic and medicolegal literature the ever-increasing attention is paid to the issues of examining traces arising as a result of additional factors of a gunshot when firing the Kalashnikov assault rifles there are no systemized data providing the possibility to differentiate traces of a close-range gunshot in forensic literature.

On the basis of a series of experimental shootings with the 5,45-mm AK-74M, AK-105, and AKS-74U assault rifles the authors conduct a comparative analysis of trace morphology at different ranges (from 0 to 200 cm) a number of the regularities allowing to differentiate the traces formed when firing of 5,45-mm Kalashnikovs of the specified models on their basis is revealed..

Along with this, applying a diffusion contact method the authors find out peculiarities of homogeneous, point, and small-focal deposits of copper ions.

All the conducted examinations allow experts to accurately differentiate traces of a close-range gunshot from the 5,45 mm AK-74M, AK-105, and AKS-74U assault rifles.

Key words: assault rifles Kalashnikov, traces of a close-range gunshot, friction band, gunpowder grains, small arms, forensic ballistic examination, shot soot.

1947 . ()

:

5,45 , 5,56 , 7,62 .

-

,

-

.

,

-

-



[1, . 27. 42; 2; 3, . 30. 45; 4].

(5,45).

208 . -74 415 , -105 . 314 , -74 .

5,45- -74 , -105 -74 .

-105 -74 5,45- -74 ,

(7 6)

0 () 200 .

-105 . -74

5 , -74 . 20 .

15 -74 -105 -74 .

90 130 .

-105 1

125 135 ; 3. 4 .

8 (.1).

-74 1 20

- 100 170 (0 7)

35 70 (10. 15).

-74 , 3 , -105 . 5 ,



-74 · 15

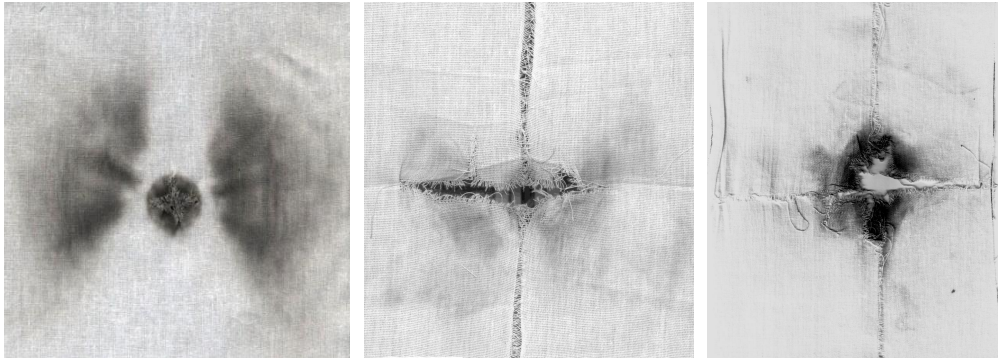

)))

. 1.

) -74 ;) -105;) -74

-74 -105

1 3 .

-74

30 .

-74 -105

10 , -74 · 35· 40 .

-74

30 , -105· 35 , -74 · 70 .

-74

7 , -105 · 15 ,

-74 · 50 .

-74 -105

25· 30 , -74 · 40· 50 ; 1 -74 · 60 ,

-105 · 50· 55 , -74 · 70· 80 ; 3 -74 .

70 , -105· 45· 50 , -74 · 70· 90 .

-74 5

-105 5

18· 22 , -74 · 110· 120 ; 7 · 15· 25 90· 105 ; 10 · 14·

23 60· 70 (.2).

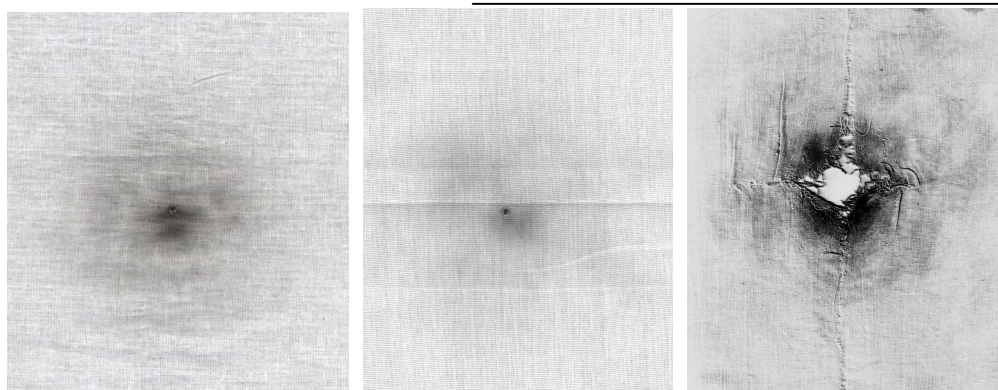

)))

.2.) -74 ;) -105;) -74 10 :
-105 15 -
-74
15 . 65- 70 ; 20 . 50- 55 ; 30 . 65-
70 ; 40 . 45- 50 .
-74 -105 0 () 3 -
200 , -105 . 160 , 1 . 240 210 -74 . -
-74 , -105 (. 1).
-105 5 10 -
10 23 , -74 15 45 . -
-74 5 , ,
180 . 5 70 . , ,
-105 15 , 130 .
10 55 . ,
-74 5 -
5 20 . (130) -
-



[5, . 7; 6 . 22· 24].

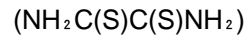

· 12 %-

« . »).

)

20 , -105 · 15 , -74 · 50 .
-74 -105

-74

· 30 , -74 · 70· 95 ; 1 .
60 , 40 95 ; 3 .
70 , 55 105 ; 5 · 95 , 70
120 ; 7 · 95 , 80 135
; 10 · 100 , 80 90 (. 3).
-105 15

15 -74
· 60 , -74 · 70 .
-74 20

-74 20
· 80 , 30 · 50 ,

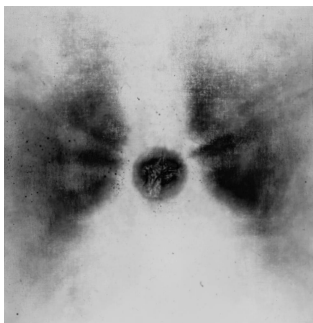

)

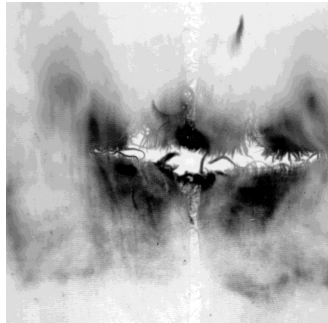

)

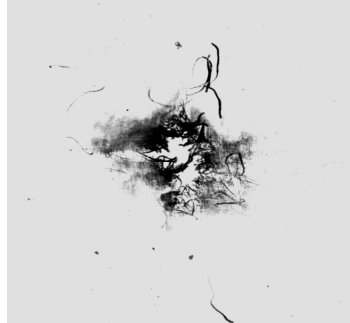

)

. 3.

) -74 ;) -105;) -74

-74 -105 5

-74

, -105 (. 3).

-74 , -105

-74



5 40 .

-74

(. 4).

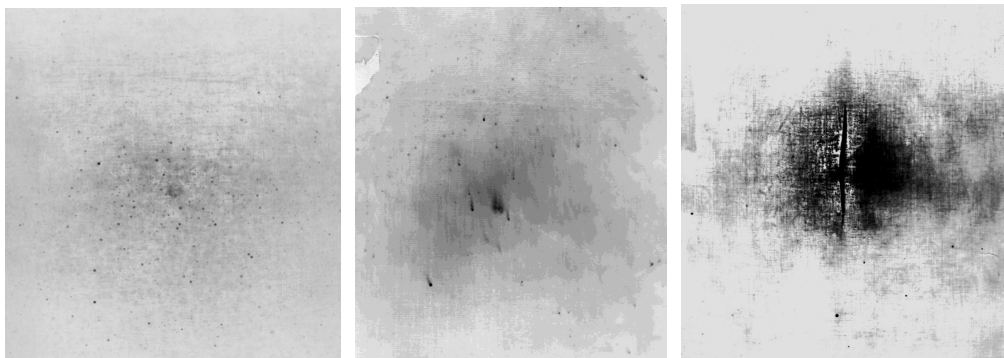

)

)

)

. 4.

20

:

) -74 ;) -105;) -74

-105 -74

5,45

5,45-

-74 , -105 -74

1.

5: 5,45-
, 2005.

-74 :

2.

7,62-



() 7,62- // .
2012. 1. . 94- 100.
3. , -
24: 5,45- -74 : / . .
[.]. : , 2013.
4. -74
5,45 / . . -
[.]// - . 1978. 2. . 17- 20.
5. : : -
, 2015.
6. : , 1965.

References

1. Andreev A. G., Latyshov I. V., Chulkov I. A. Strelkovoe ognestrel'noe oruzhie i ego sledy na puljah, gil'zah i pregradah. Chast' 5: 5,45-mm avtomat AKS-74U: sprav.-metod. posobie. Volgograd: VA MVD Rossii, 2005.
2. Rezvan A. P., Nikitin I. I., Chulkov I. A. Sravnitel'nye karakteristiki sledov blizkogo vystrela pri strel'be iz 7,62-mm avtomata Kalashnikova (AKM) i 7,62-mm samozarjadnogo karabina Simonova // Sudebnaja jekspertiza. 2012. 1. S. 94- 100.
3. Strelkovoe ognestrel'noe oruzhie i ego sledy na puljah, gil'zah i pregradah. Chast' 24: 5,45-mm avtomat AK-74M: sprav. posobie / A. S. Kopanev [i dr.]. Volgograd: VA MVD Rossii, 2013.
4. Povrezhdenija, prichinennye vystrelami iz avtomata AKS-74 kalibra 5,45 mm materialam odezhdy, kozhnym pokrovam i kostjam trupa / M. I. Marchenko [i dr.] // Sudebno-medicinskaja jekspertiza. 1978. 2. S. 17- 20.
5. Afanas'ev I. B., Judina T. Ju. Diffuzno-kontaktnyj metod pri issledovanii sledov produktov vystrela: metod. rekomendacii. Moskva: JeKC MVD Rossii, 2015.
6. Kustanovich S. D. Issledovanie povrezhdenij odezhdy v sudebno-medicinskoj praktike. M.: Medicina, 1965.

©, 2018

CONTACT INFORMATION

Akifeva Galina Vyacheslavovna
akifeva_galina@mail.ru

Bozhchenko Alexander Petrovich
bozhchenko@mail.ru

Bobovkin Mikhail Victorovich
mbobovkin@yandex.ru

Butyrin Andrey Yurievich
info@sudexpert.ru

Vasiliev Vasily Alexeevich
v-vasiliev@inbox.ru

Vasilchuk Alexey Sergeevich
ife@ro.ru

Vekhov Vitaliy Borisovich
v-vehov@mail.ru

Gomon Anna Alexandrovna
morz@inbox.ru

Danilkin Igor Anatolyevich
i-danilkin@mail.ru

Danilovich Vladimir Borisovich
dvv@mtsbank.ru

Evstropov Dmitry Anatolyevich
dmitry.evstropov@gmail.com

Ilyin Nikolay Nikolaevich
nick703@yandex.ru

Kitaev Evgueniy Vladimirovich
kitaevy@mail.ru

Kovalev Sergey Aleksandrovich
skovalv@mail.ru

Kozlov Vladimir Leonidovich
kozlovvl@bsu.by

Komnatin Vladimir Gennadievich
komnatin.vladimir@yandex.ru

Kopanev Alexey Sergeevich
kopanev_78@mail.ru

Koshmanov Mikhail Petrovich
8-927-527-40-22

Koshmanov Peter Mikhailovich
koshm77@mail.ru

Krainsky Alexander Vladimirovich
krainskii.a@mail.ru

Lappo Egor Alexandrovich
lapa.eko_part@tut.by

Matveichev Yury Anatolyevich
matveichau@mail.ru

Rubis Alexandr Sergeevich
mr.rubis@gmail.com

Ruchkin Vitaly Anatolievich
v.ruchkin@yandex.ru

Chulkov Igor Alexandrovich
chulkov0902@mail.ru

« »,

« »

4

500

77-47195.

« » - 46462.

Word. Microsoft Equation. Excel, (TIFF JPEG, 300 dpi).

7.0.5- 2008.

- 1.
2. (120 250).
- 2.1.
- 2.2.
- 2.3.
- 2.4.
- 2.5.
3. 2
4. ()
- 5.

7.0.5- 2008.

: « () ».

1

2 () (5- 15) ()

».
: «
».
:
(: **www.va-mvd.ru/sudek/**);
-
-
(**c-expertisa@yandex.ru**);
-
-
(
);
-
(
).
,
,
() :
400089, , 130,
,
« »
e-mail: c-expertisa@yandex.ru
-
,
,
.
.
:
(8442) 31-41-22, (8442) 24-83-62.

Редактор *Е. Ю. Провоторова*
Компьютерная верстка *А. А. Сеницыной*
Дизайн обложки *Н. Н. Грибановой*

Адрес издателя: 400089, Волгоград, ул. Историческая, 130,
Волгоградская академия МВД России

Адрес редакции журнала: 400089, Волгоград, ул. Историческая, 130,

Подписано в печать 15.03.2018. Дата выхода в свет: 27.03.2018.

Формат 60X84/8. Бумага офсетная. Гарнитура Arial. Физ. печ. л. 17,0. Усл. печ. л. 15,8.
Тираж 500. Заказ 8. Цена по подписке по каталогу «Роспечать» 413 руб. 44 коп. (2 номера).

Отпечатано в ОПиОП РИО ВА МВД России. 400131, Волгоград, ул. Коммунистическая, 36.